



USER MANUAL

Ilaria/Nadia 24B/24BDD

Boiler Stoves



*Instructions for the correct use and maintenance of
your Kalor wood pellet boiler stove*

Distribution and warranty in Ireland by:

woodpelletstoves.ie

A note from the distributor:

Congratulations and thank you for choosing a Kalor wood pellet stove. Kalor is a leading wood pellet stove brand worldwide, offering leading combustion efficiencies and superior reliability. You have chosen well!

Kalor stoves are distributed in Ireland by Wood Pellet Stoves.ie, through a network of Authorised Dealers. We are a company, totally dedicated to wood pellet stoves and our priorities are quality not just of product but also of installation and maintenance.

We also offer a nationwide network of Authorised Technicians who are specially trained on Kalor wood pellet stoves. This ensures that your stove can be correctly installed, commissioned, maintained and repaired by competent personnel and that you receive the best possible service, all the way from purchasing your stove to the end of it's life-cycle.

Please refer to the notes on the inner back cover of this manual for further details regarding the installation, commissioning and warranty for your stove.

We wish you all the best with your new Kalor stove and hope it serves you well for many, many years.

Yours sincerely,



Fergus Mc Manamon

General Manager

Wood Pellet Stoves.ie

We thank you for having chosen one of our products, the fruit of technological experience and of continual research for a superior quality product in terms of safety, dependability, and service.

In this manual you will find all the information and useful suggestions to use your product with the maximum safety and efficiency.



We highly recommend to turn to our Authorized Service Centre for the installation and the first ignition of the device as it not only carries out the installation perfectly but also verifies the regular operation of it.

- Incorrect installation, incorrectly performed maintenance, improper use of the product release the manufacturer from every eventual damage derived from the use of the stove.
- The unit cannot be used as an incinerator. Do not use fuels other than pellets.
- This manual has been realized by the manufacturer and constitutes an integral part of the product and must remain with it during its entire lifetime. If the product is sold or transferred, be sure that the booklet is present since the information contained in it are addressed to the buyer, and to all those persons of various titles who complete the installation, use and maintenance.
- Carefully read the instructions and the technical information contained in this manual, before proceeding with the installation, use, and any operation on the product.
- The observance of the indications contained in the present manual guarantees the safety of people and the product, the economy of use and a longer functioning lifetime.
- Although the carefully studied design and the risk analysis done by our company has permitted the realization of a safe product, in any case, before effecting any operation on the stove, it is recommended to keep said manual available and pay scrupulous attention to the instructions written therein.
- Be very careful when moving the ceramic details where present.
- Check the precise flatness of the pavement where the product will be installed
- The wall where the product will be placed must not be constructed in wood, or in any case, made of an inflammable material, and in addition it is necessary to maintain a safety distance.
- While the stove is in operation, several parts of the stove (door, handle, sides) can reach high temperatures. Therefore pay attention and use the proper precautions, above all in the presence of children, elderly or disabled persons, and animals.
- Assembly must be performed by authorized persons (Authorized Assistance Center).
- Diagrams and drawings are furnished for the purpose of illustration; the manufacturer, with the intent of pursuing a policy of constant development and renewal of the product can, without any notice, make any modifications that are believed opportune.
- When the stove is working at its maximum speed, it is strongly suggested to wear gloves while handling with the door for pellets loading and the door handle.
- It is prohibited to install in bedrooms or in explosive environments.
- Only use replacement parts recommended by the supplier.



Never cover the body of the stove in any way or obstruct the openings placed on the upper side when the device is operating. All our stoves are trial lighted on the construction line.

In the event of a fire, disconnect the power supply, use an extinguisher and call the fire fighters if necessary. After that contact the Authorized Assistance Center.

This instruction booklet is an integral part of the product: make sure that it always accompanies the appliance, even in case of transfer to another owner or in the case of transfer to another place. In the event of damage or loss, request a copy from the area technician.

These symbols indicate specific messages in this booklet:



ATTENTION:

This warning sign indicates that the message to which it refers should be carefully read and understood, **because failure to comply with what these notices say can cause serious damage to the stove and put the user's safety at risk.**



INFORMATION:

This symbol is used to highlight information which is important for proper stove operation. Failure to comply with these provision will compromise use of the stove and its operation will not be satisfactory.

Norms and declarations of conformity

Our company declares that the stove conforms to the following norms for the EC European Directive labelling:

- 2014/30 UE (regulation EMCD) and following amendments;
- 2014/35 UE (Low Voltage Directive) and following amendments;
- 2011/65 UE (RoHS 2 directive);
- The New Rules of Construction Products (CPR-Construction Products Regulation) No. 305/2011 regarding the construction world;
- For installations in Italy, please refer to UNI 10683/98 or following changes. For the water-thermo-sanitary equipment, let the installer give you the conformity declaration in compliance with L. 37/2008. While installing the unit respect the local, national and European rules;
- EN 55014-1; EN 55014-2; EN 61000-3-2; EN 61000-3-3; EN 60335-1; EN 60335-2-102; EN 62233, EN 50581.

Safety information

Please carefully read this use and maintenance manual before installing and operating the stove!

If clarification is needed, please contact the dealer or the Authorized Assistance Center.

- The pellet stove must only be operated in living environments. This stove, being controlled by an electronic board, permits a completely automatic and controlled combustion; the exchange, in fact, regulates the lighting phase, 5 power levels and the shut down stage, guaranteeing the safe operation of the stove.
- The basket used for combustion allows most of the ash produced by the combustion of the pellets to fall into the collection compartment. Nevertheless, check the basket daily, given that not all pellets have high quality standards (use only quality pellets recommended by the manufacturer).

Responsibility

With the delivery of the present manual, we decline all responsibility, both civil and penal, for accidents deriving from the partial or total lack of observance of the instructions contained herein.

We decline every responsibility derived from improper use of the stove, from incorrect use by the user, from unauthorized modifications and/or repairs, from the use of replacement parts that are not original for this model.

The manufacturer declines every civil or penal, direct or indirect responsibility due to:

- Lack of maintenance;
- Failure to observe the instructions contained in the manual;
- Use in non-conformity with the safety directives;
- Installation in non-conformity with the norms in force in the country;
- Installation by unqualified or untrained personnel;
- Modifications and repairs not authorized by the manufacturer;

- Use of non-original replacement parts;
- Exceptional events.



- Use only wood pellets;
- Keep / store the pellets in a cool dry place;
- Never pour pellets directly on the hearth;
- The thermostove must only be fed with quality 6 mm diameter pellets of the type recommended by the manufacturer;
- Before making the electrical connection of the thermostove the discharge tubes must be connected with the flue;
- The protective grill placed inside the pellet container must never be removed;
- The environment where the stove is installed must have a sufficient exchange of air;
- It is forbidden to operate the thermostove with the door open or the glass broken;
- Do not use the thermostove as an incinerator; the thermostove should be used only for the intended purpose;
- Any other use is considered improper and therefore dangerous. Do not put in the hopper other than wood pellets;
- When the thermostove is operating, the surfaces, glass, handle and tubes become very hot: during operation do not touch these parts without adequate protection;
- Keep the fuel and other inflammable materials off the thermostove.

Fuel is loaded from the upper part of the stove by opening a door.

Pour the pellets in the hopper; vacuum contains about 42 kg of pellets.

This is easier if performed in two steps:

- Pour half of the contents of the bag into the hopper and wait for the fuel to settle on the bottom.
- Then pour in the second half;
- Keep the cover closed, after loading the pellets, the lid of the fuel tank;

The thermostove is a product by heating, presents the external surfaces particularly hot. For this reason, we recommend extreme caution when operating in particular:

- Do not touch the stove body and the various components, do not approach the door, it could cause burns;
- Do not touch the exhaust fumes;
- Do not perform any type of cleaning;
- Do not dump the ashes;
- Do not open the ash tray;
- Be careful that children do not come near;



Never remove the protection grille in the hopper. When filling, do not let the sack of pellets touch any hot surfaces.

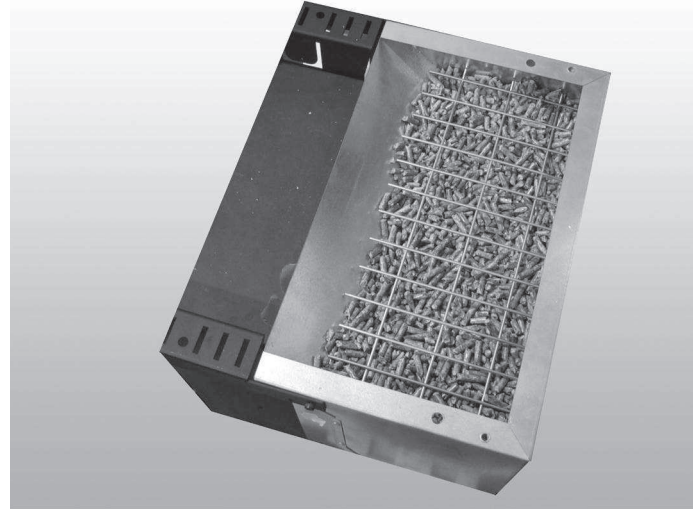

Instructions for safe and efficient use

- The device can be used by children that are not less than 8 years old and people with reduced physical, sensory or mental capabilities, or lack of experience or knowledge, provided being under supervision of someone responsible or after having received instructions relating to the safe use of the device and to the understanding of the dangers inherent to it. Children should not play with the device. Cleaning and maintenance to be performed by the user should not be made by children without supervision;
- Do not use the thermostove as a ladder or scaffold;
- Do not put clothes to dry on the thermostove. Any clothes hangers and suchlike must be kept a suitable distance from the stove. - Risk of fire
- Carefully explain that the thermostove is made from material subjected to high temperatures for the elderly, the disabled, and in particular for all children, keeping them away from the thermostove during operation
- Do not touch the thermostove with wet hands: the thermostove has electrical components that could produce sparks if handled incorrectly.
- Never open the glass door of the pellet stove while the thermostove is in operation.
- The thermostove must be connected to an electrical system equipped with an earthing conductor in accordance with regulations 73/23 and 93/98 EEC;
- The system must be of adequate electrical power declared the thermostove;
- Do not wash the inside of the thermostove with water. The water could damage the electrical insulation, causing electric shock;
- Do not expose your body to hot air for a long time. Do not overheat the room you are in and where the thermostove is installed. This can damage the physical conditions and cause health problems;
- Do not expose to direct the flow of hot air plants or animals;
- The pellet thermostove is not a cooking element;
- External surfaces during operation can become very hot. Do not touch them except with the appropriate protection.
- The plug of the device power cable must be connected only after installation and assembly of the device and must remain accessible after installation, if the unit is not provided of a double-pole switch suitable and accessible.

Operating area

For proper functioning and a good temperature distribution, the stove should be positioned in a location where it is able to take in the air necessary for combustion of the pellet (about 40 m³/h must be available), as laid down in the standard governing the installation and in accordance with local national standards.

The volume of the room must not be less than 30 m³.

The air must come in through permanent openings made in walls (in proximity to the stove) which give onto the outside, with a minimum cross-section area of 100 cm².

These openings must be made in such a way that it is not possible for them to be obstructed in any way. Alternatively, the air can be taken from rooms adjacent to the one which needs ventilating, as long as they are provided with an air intake from the outside, and are not used as bedrooms or bathrooms, and provided there is no fire risk such as there is for example in garages, woodsheds, and storerooms, with particular reference to what is laid down in current standards.



It is not permissible to install the thermostove in bedrooms, bathrooms, or in a room where another heating appliance is installed (fireplace, stove etc.) which does not have its own independent air intake.

Locating the thermostove in a room with an explosive atmosphere is prohibited.

The floor of the room where the thermostove is to be installed must be strong enough to take its weight. If walls are flammable, maintain a minimum distance of 10 cm at the rear (A), of 40 cm at the side (B) and 100 cm at the front.

If the room contains objects which are believed to be particularly delicate, such as drapes, sofas and other furniture, their distance from the thermostove should be considerably increased.

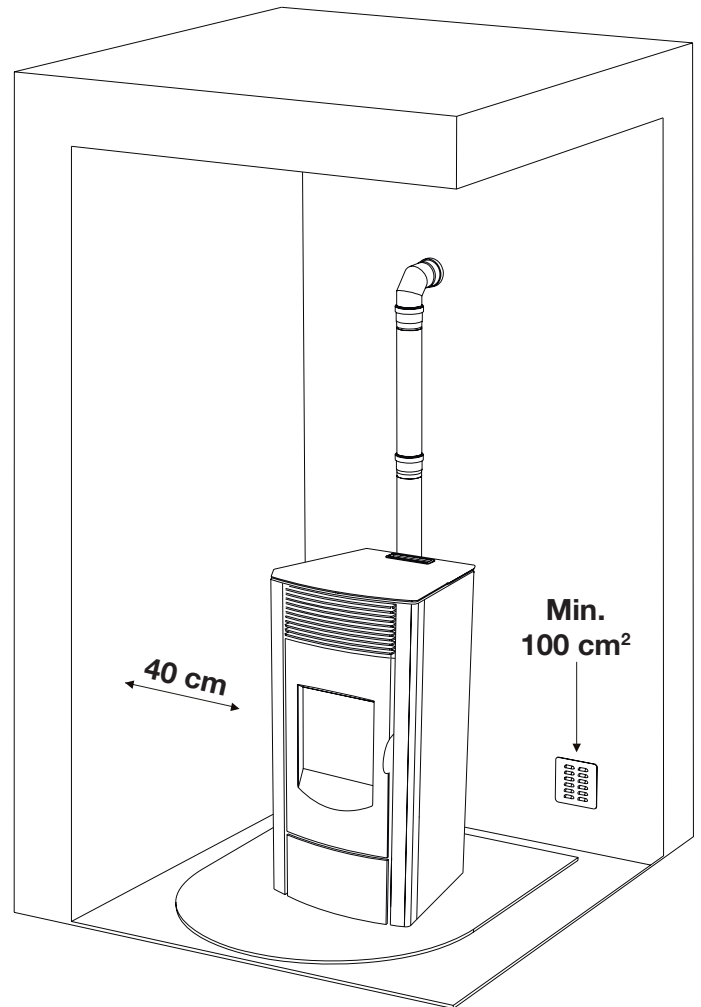

Connection to the external air intake

It is essential that at least as much air must be able to flow into the room where the thermostove is installed as is required for proper combustion in the appliance and for the ventilation of the room.

This can be effected by means of permanent openings in the walls of the room to be ventilated, which give onto the

outside, or by single or collective ventilation ducts.

For this purpose, on the external wall near the thermostove, a hole must be made with a minimum free cross-section of 100 cm². (equivalent to a round hole of 12 cm diameter or a square hole 10x10 cm) protected by a grille on the inside and the outside.

The air intake must also: communicate directly with the room where the thermostove is installed be protected by a grille, metal mesh or suitable guard, as long as this does not reduce the area below the minimum.

Be positioned in such a way as to be impossible to obstruct.



In the presence of wood floors, install a floor protection surface in compliance with the rules in force in the country

Connection to the flue pipe

The flue pipe must have internal dimensions not larger than 20x20 cm, or diameter 20 cm. In the event of larger dimensions, or of the flue pipe being in poor condition (for example cracks, poor insulation, etc.), it is advisable to fit a stainless steel pipe of suitable diameter inside the flue pipe throughout its length, right up to the top.

Check with suitable instruments that there is a draught between 5 Pa and 10 Pa. This type of connection ensures the evacuation of the fumes even in the event of a temporary power cut.

At the bottom of the flue pipe, provide an inspection cap to allow periodic checking and cleaning, which must be done annually. Make a gas-tight connection to the flue pipe, using pipes and connectors as recommended by us. You must ensure that a windproof cowl should be fitted which complies with the standards in force

Connection to an external flue with insulated or double-wall pipe

The only type of pipe which is permissible is insulated (double-walled) stainless steel, smooth on the inside, fixed to the wall. Flexible stainless steel pipe must not be used. At the bottom of the flue pipe, provide an inspection cap to allow periodic checking and cleaning, which must be done annually. Make a gas-tight connection to the flue pipe, using pipes and connectors as recommended by us. You must ensure that a windproof cowl should be fitted which complies with the standards in force.

Check with suitable instruments that there is a draught between 5 Pa and 10 Pa.

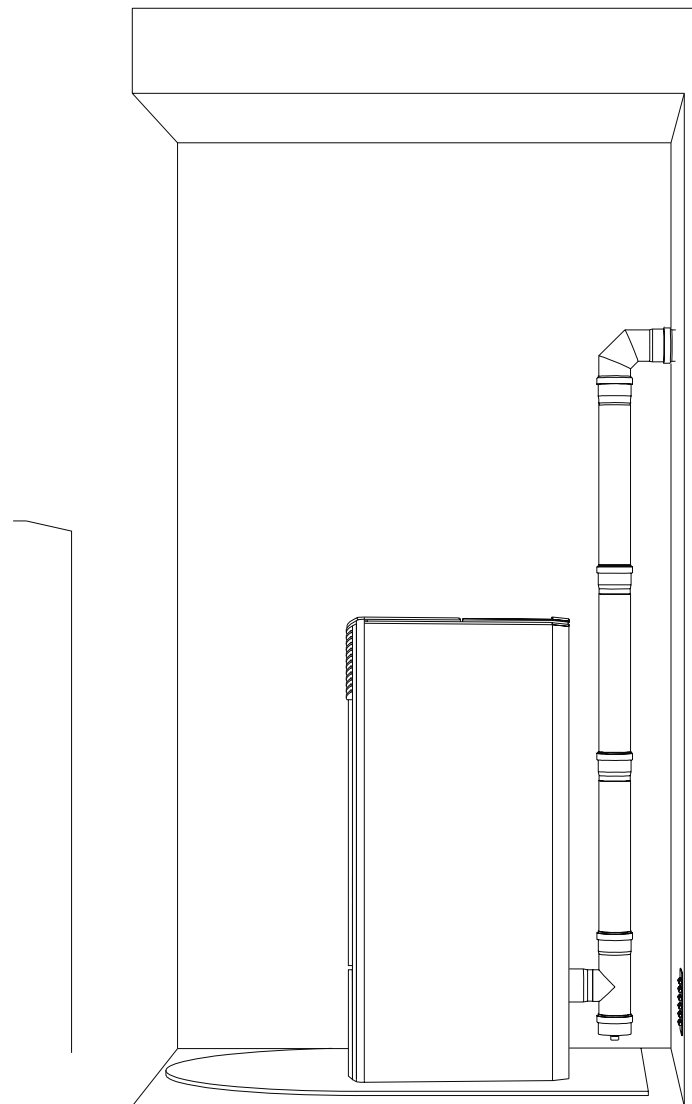

Connection to the flue pipe

For proper functioning, the connecting pipe between the stove and the chimney or flue duct must have a slope of not less than 3% in the horizontal stretches, the length of which must not exceed 2 metres and the vertical distance between one tee connector and another (change of direction) must not be less than 1,5 m.

Check with suitable instruments that there is a draught between 5 Pa and 10 Pa. At the bottom of the flue pipe, provide an inspection cap to allow periodic checking and cleaning, which must be done annually.

Make a gas-tight connection to the flue pipe, using pipes and connectors as recommended by us. You must ensure that a windproof cowl should be fitted which complies with the standards in force.

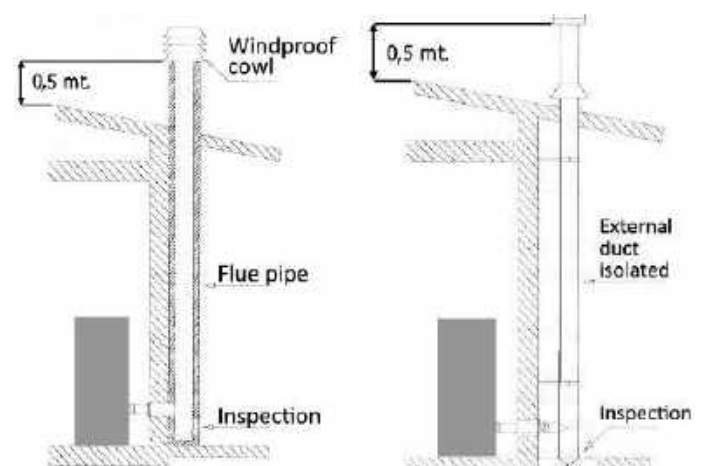

Fig. 2: connection to the flue pipe.

Fig. 3: connection to an external flue with insulated or double-wall pipe.

Fireplace flue gas

Avoid contact with combustible materials (example: wooden beams) and in any case provide for their insulation with flame retardant material. In case of pipe penetrations through roofs or walls is recommended to use special kits crossing, certificates, are available commercially. In the event of a chimney fire, turn off the stove, disconnect from the network and never open the door. Then call the authorities.

The chimney cap

The chimney cap must respect the following requirements:

- It must have the equivalent diameter and internal form of the flue.
- It must have a useful outlet diameter of not less than double that of the flue.
- The chimney cap on the roof or that remains in contact with the outside (for example, in case of open lofts or attics), must be covered with elements in brick or tile and must, in any case, be well insulated.
- It must be constructed to prevent rain, snow, and extraneous bodies from entering the flue and so that the discharge of the products of combustion is not inhibited by wind from any quarter or strength (wind-proof chimney cap).
- The chimney cap must be positioned in such a way as to guarantee the adequate dispersion and dilution of the products of combustion and in any case, must be out of the reflux zone. This zone has different dimensions and forms according to the angle of inclination of the roof so it is necessary to adopt minimum heights (Fig. 2).
- The chimney cap must be a wind-proof type and must be above the ridge.
- Eventual structures or other obstacles that are higher than the chimney cap must not be too close to the chimney cap itself.

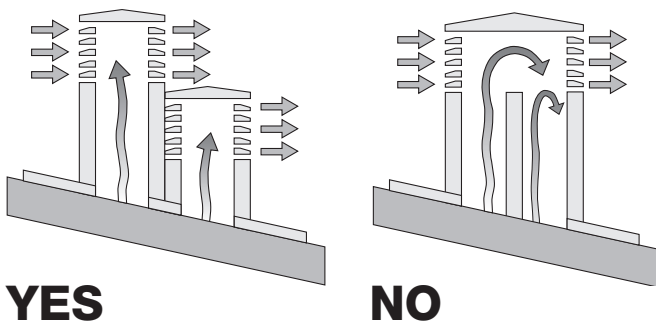
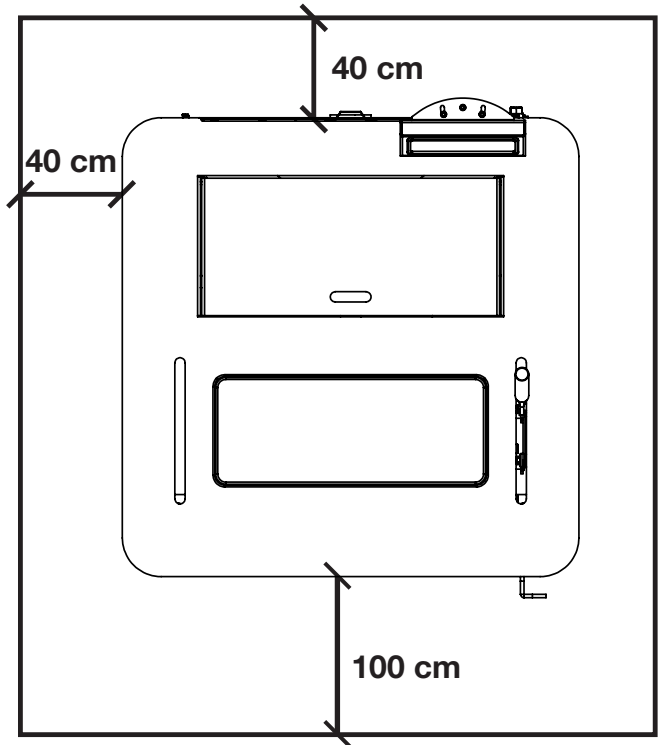

Fig. 5: Characteristics of chimney

Distance to objects

The thermostove should be inspected on all sides, so you have to keep a distance of at least 40 cm at the back and sides. It is also recommended to keep the pellets and all flammable materials at a suitable distance







REMARKS:

- the appliance must be installed by a qualified technician in possession of the technical and professional requirements according to the DM37/2008 that, under its responsibility, to ensure compliance with the rules of good technique.
 - the thermostove must be connected to a heating system and/or to a network of production of sanitary hot water, consistent with its performance and its power
 - you need to keep in mind all laws and national, regional, provincial and municipal laws of the country in which you installed the device
 - check that the floor is not flammable: if necessary use a suitable platform
 - in the room where the generator must be installed to heat must not pre-exist or be installed with an extractor hood or ventilation ducts of the collective type.
- Should these devices be located in adjacent rooms communicating with the installation, and 'prohibited the simultaneous use of the heat generator, where there is a risk that one of the two rooms being placed in depression than the other
- it is not permissible to install in bedrooms or bathrooms
 - for hydraulic connections (see next chapter) it is advisable to use where possible of hoses

Remote Control

The remote control (Fig. 3) used to adjust water temperature power and the on/off functions for the pellet thermostove.

To start the thermostove, press key  and the stove will automatically enter the starting phase.

Press keys + (1) and - (2) to adjust temperature, and use keys + (6) and - (5) to adjust operating power.

To turn off the thermostove, hold down key .

To replace the 3 volt battery located on the back of the remote control, pull the centre of the cover and the lever on the side of the same, replace the battery observing the correct polarity (Fig. 4)



Technical Specification

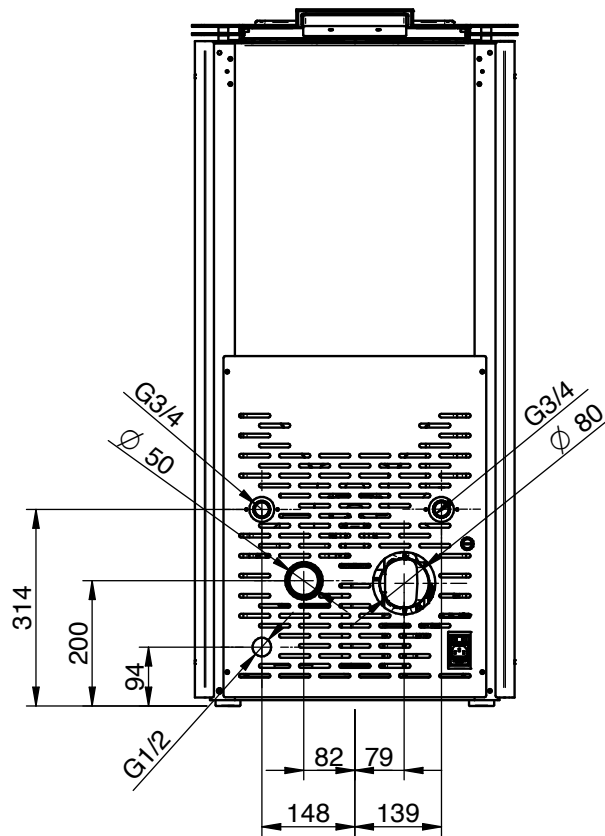
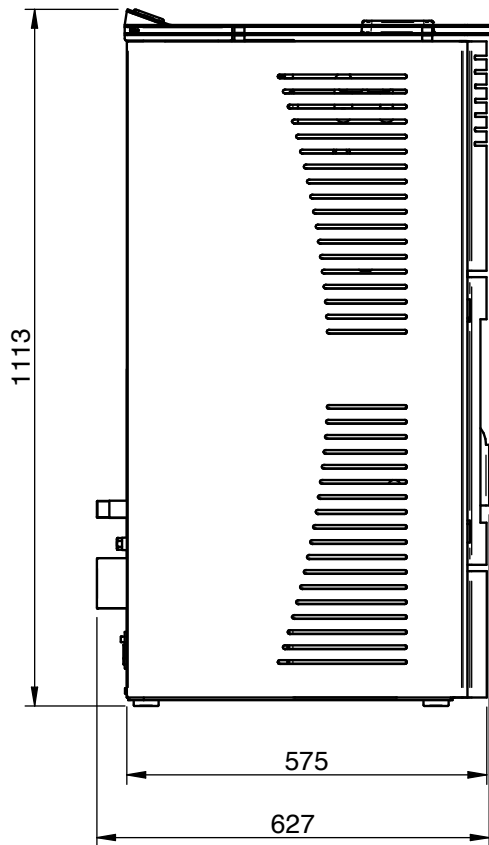

N.B.: measures with a tolerance of about 10 mm

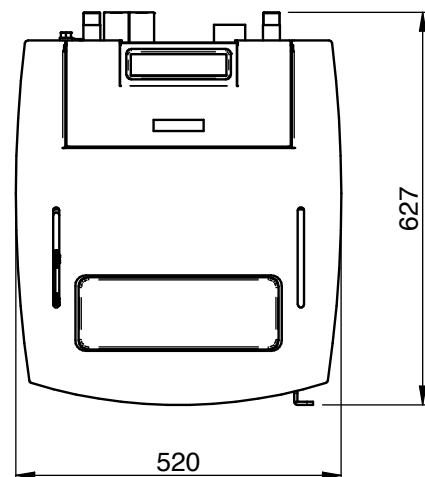

PARAMETER	M. UNITS	TH17
Heat input	kW	18,03
Nominal heat output	kW	17,14
Reduced heat output	kW	4,00
Water heat output	kW	13,70
Reduced water heat output	kW	3,10
CO concentration at nominal reference (13% O ₂)	mg/m ³	48,23
CO concentration at reduced reference (13% O ₂)	mg/m ³	345,4
Nominal efficiency	%	94,90
Reduced efficiency	%	97,54
Pellet consumption (min-max)	Kg/h	0,84 - 3,79
Heated surface	mc	430
Flue gas flow rate (min-max)	g/s	3,02 - 11,04
Draft (min-max)	Pa	3 - 8
Flue gas temperature (min-max)	°C	51,1 - 103
Boiler water	litri	31
Maximum working pressure	Bar	2,5
Tank capacity	Kg	33
Smoke outlet tube	mm	80
Diameter air intake	mm	50
Connecting heating	Inch	3/4
Connecting health	Inch	1/2
Nominal voltage	V	230
Nominal frequency	Hz	50
Power consumption max	W	370
Thermostove weight	Kg	230
N° Test Report		K 1969 2016 T1
EEL		130
Ambiental decree n.186		★★★★☆
Energetic class		A++

Plumbing system connection



The connection of the stove to the plumbing system must be made **ONLY** by specialized personnel who are capable of carrying out installation properly, in compliance with current standards in the country of installation. The manufacturer will not be held responsible for damage to persons or things in the event of failed operation if the aforementioned warning is not complied with.

There are 2 different types of systems:

- Closed vessel system
- Open vessel system.

Closed vessel system

This product has been designed and built to work with closed vessel systems. In general, the closed vessel system has the following expansion as the expansion vessel pre-loaded. In addition to the expansion device, the closed vessel system must be provided in accordance with current Italian UNI 10412-2 (2009) by:

- safety valve
- thermostat control of the circulator
- device alarm sounds
- temperature Indicator
- pressure indicator
- audio alarm
- automatic adjustment
- safety thermostat with manual reset
- circulation system

Diagram connection kit without hot water thermostove

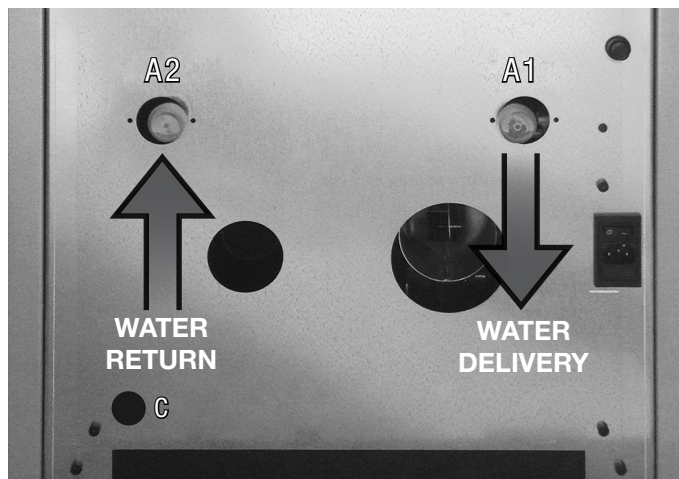

The pressure relief valve (C) must always be connected to a water drain pipe. The tube must be capable of withstanding high temperature and pressure.

Directions for use

If the installation of the thermostove provides interaction with another existing system complete with a heater (gas boiler, gas boiler, oil boiler, etc..) consult qualified personnel who can then answer the compliance of the system, as envisaged by the law in force.

Flushing the system

In accordance with the UNI-CTI 8065 is strongly recommended to wash the entire system before connecting it in order to get rid of residues and deposits. After flushing the system to protect it against corrosion and deposits, it is recommended the use of inhibitors.

Upstream from the stove, always install shutters so as to disconnect it from the plumbing system should it be necessary to move it, or when it requires routine and/or special maintenance. Connect the stove using hoses so that the stove is not too strictly connected to the system, and to allow slight movement.

In case it is necessary additional water it is necessary to be made the filling process when the heater is cooled to room temperature.

These are precautions to prevent the arising of thermal stress of the steel body of the heating stove.

- In plants equipped with open vessel the water pressure in the heating stove, (when the system is cold) , must not be less than 0.3 bar;
- the water used for filling the heating system must be decontaminated and without air.



Do not mix the heating water with antifreeze or corrosion substances in the wrong concentrations.

It can damage the seals and cause the occurrence of noise during operation. The manufacturer declines all responsibilities if damage caused to people, animals or property caused if above instructions are not followed.

When all the hydraulic connections are done, proceed to test the pressure of the seals, through the filling of the heating stove.

The loading valve is necessary and must be provided in the hydraulic system.

This operation must be done with caution, respecting the following steps:

- open the air vent valves, the heater and the plant;
- open gradually the system filler tap, checking that all automatic purging air valves installed, are operating properly;
- close the radiators venting valves as soon as water flows;
- check on the manometer placed on the system that the pressure reaches about 1 bar (applies only to systems with a closed vessel, to consult any local regulations or standards that allows it); for open vessel, the reintegration is automatic through the vessel itself;
- close the system filler cock and again release the air through the vent valves of the radiators;



Filling of the system

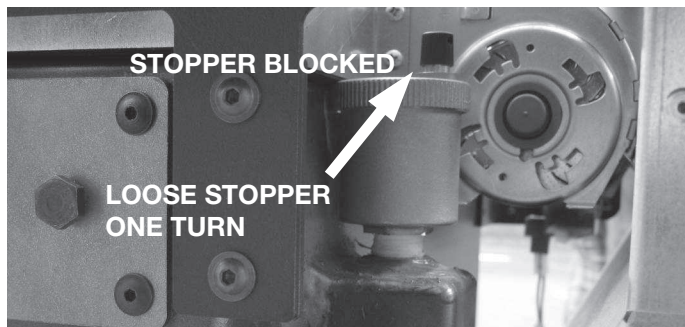

Filling must be done slowly in order to allow the air bubbles to come out through the appropriate vents placed on the heating system.

In Thermal systems with closed circulation the loading pressure with cold boiler and the preloading pressure of the expansion vessel must be equivalent.

• In Thermal systems with open circulation, it is possible the direct contact between the circulating liquid and the air. During the heating season, the user must regularly check the level of water circulating in the expansion tank. The content of water in the recirculation system must be kept constant.

Practical experience shows that a regular check of the water level should be made every 14 days in order to maintain a fairly constant water content.

Water Characteristics

The characteristics of the water used to fill the system are very important to prevent the build-up of mineral salts and the formation of incrustations along the pipes, in the boiler and in the heat exchangers.

Therefore, please get your plumber's advice concerning:

- Hardness of water circulating in the system, to prevent problems of incrustation and limescale, especially in the domestic water heat exchanger (>25° French).
- Installation of a water softener (if water hardness > 25° French).
- Filling the system with treated water (demineralised).

If you have very extensive system, with a large amount of water, or which require frequent refilling, it is recommended the installation of water softening system. It 'should be noted that the encrustations drastically reduce performance because of their low thermal conductivity.

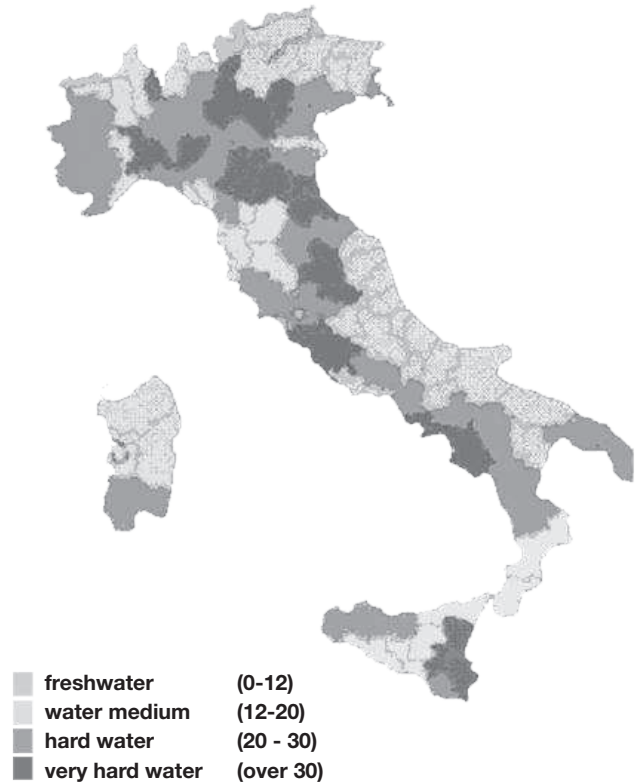

To guarantee the results of the certifications (see technical table) it is necessary to have the same laboratory conditions and to install the same parameters of the performance tests.

Only authorized technicians have these parameters and they will be able to install only after having verified that the conditions of draft of the flue and of the combustion oxygen are the same of those of the tests.

CB Configuration of the hydraulic diagram of the boiler

BY A SPECIALIZED TECHNICIAN

Before starting the boiler, it is necessary to configure the hydraulic scheme on which we want to work. The boiler is set up to receive the clean contact of an external thermostat (open / closed, the thermostat must not give tension to the back. If the thermostat carries voltage to the board causing faults, the warranty is void), two temperature probes and a motorized valve. All these components can be connected via the terminal board on the back of the boiler.

Electrical diagram of the control unit

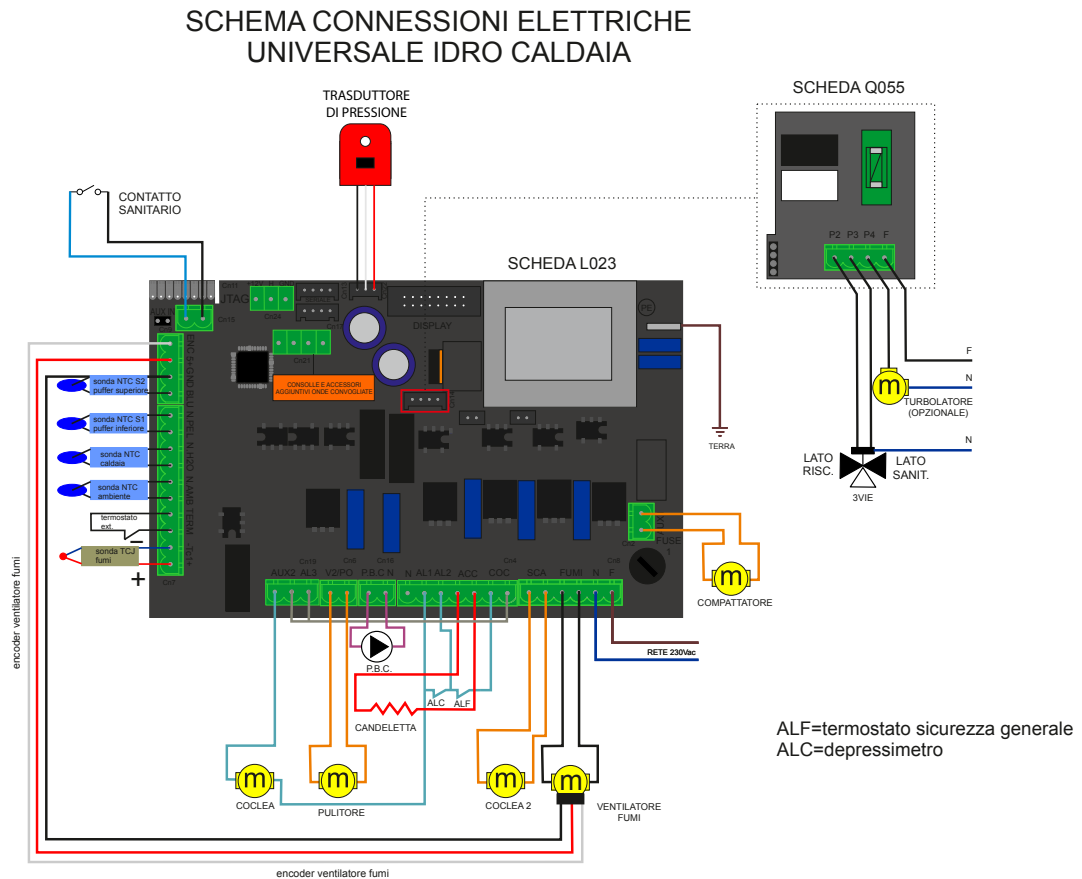

Per il tecnico specializzato:

To configure the hydraulic diagram, press the SET key and then 🔽 scroll to the "Technical settings" menu with the power key. Press the SET key again to enter the menu and enter the access key in possession of only the technician authorized by the manufacturer. Confirm the password using the set key and the key 🔽 of the power go to menu 3 "hydraulic scheme". Confirm with the SET key and use the 🔼 and 🔽 keys to select the required hydraulic scheme number.

For end user:

It is possible to change the boiler operating principle according to the season by choosing between summer and winter. To select the season press SET, the season selection will appear on the display. Then press the set key again and select the season with keys 1 and 2. Once selected, press the ON / OFF key to exit. The choice of season changes the boiler operation, see next chapter.

Following the principles of operation of the various hydraulic diagrams.

Important considerations:



- healthcare will always have priority
- There are three types of stand-by:
 - Type 01:** the ambient temperature detected by the probe on the board has reached the SET AIR set
 - Type 02:** the water temperature in the boiler has reached the SET H2O set
 - Type 03:** the external thermostat has detected that the desired temperature has been reached and therefore the contact is open.



In this specific case the boiler behaves as follows:

If the thermostat carries voltage to the card causing faults, the warranty will expire.

To configure the thermostat, simply remove the jumper on the THERM terminal (see the tab on page 16) and connect our room thermostat, OPERATION BY A SPECIALIZED TECHNICIAN.

How to select the type of Stand-by (OPERATION BY A SPECIALIZED TECHNICIAN):



Press the SET button; press button  to go to menu 09. Press the SET button again. Enter the access key and confirm it by pressing the SET key again. Press the  key to go to menu 9-5.

The display will show the different stand-by modes mentioned above, choose the mode using the  and  keys.

NOTE: The hydraulic scheme 00 is set by default, the WINTER season with stand-by mode 02.

When the stove is switched off manually or by programming, automatic ignitions exit from a stand-by state will not be possible.

How to enable or disable the stand-by mode:

Press the SET button. With the , key, go to menu 05 and confirm with the SET key. Use key  to select whether to enable (ON) or disable (OFF) the boiler stand-by function.

Press the ON / OFF button to exit 

Let's see specifically the behavior of the boiler according to the hydraulic scheme, the presence and the stand-by mode and the chosen season

Scheme 00 : Boiler connected to the heating circuit and to a sanitary kit equipped with a flow switch. Defeated scheme, the absence of the sanitary kit does not cause problems to the functioning of the boiler

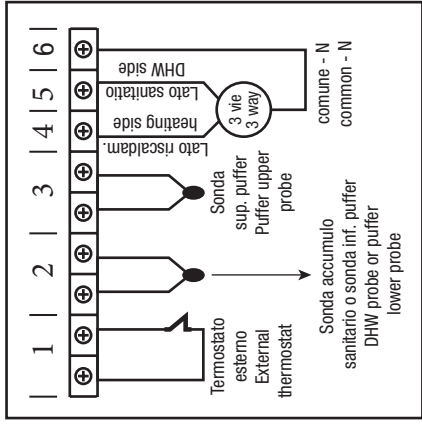
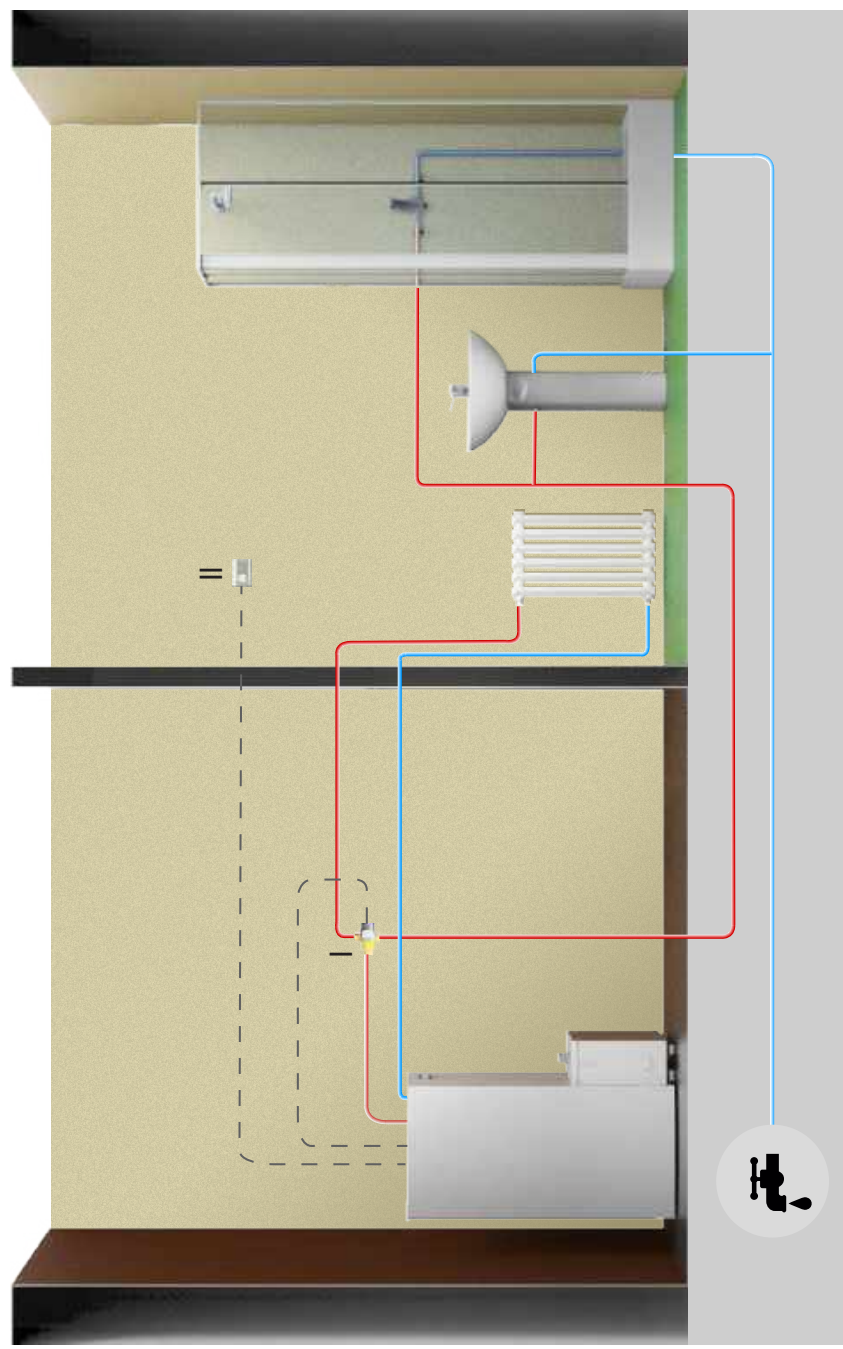

I = Valve motorization (4-5-6)
 II = External thermostat On / OFF for stand-by type 3 (optional) (1)

the scheme is indicative and wants to demonstrate only the components that can be managed by the boiler. Any relay pumps must be controlled separately from the boiler

- a) To set the water temperature in the boiler, press the e .
- b) To set the desired temperature in the room (using the probe on the board) press the key. Increase or decrease degrees with the and keys.
- c) To set the work power, press the key and adjust it with the e .

Reaction from the stand-by state is when a heat increase is required to return to a chosen stand-by condition (when it is set to ON) or when there is a health risk.

hydraulic scheme		stand-by	stand-by type	season	boiler circulator status	boiler status
HEATING + SANITARY	SANITARY DOES NOT CALL	OFF	01 (AMB.)	WINTER	ON IF H2O > PARAM.25	MODULE IF PROBE H2O> SET H20 (a) OR IF AMB PROBE. > AIR SET (b)
HEATING + SANITARY	HEALTH CALL	OFF	01 (AMB.)	WINTER	ON IF H2O > PARAM.25	MODULE IF PROBE H2O> 80 ° C
HEATING + SANITARY	SANITARY DOES NOT CALL	ON	01 (AMB.)	WINTER	ON IF H2O > PARAM.25	STAND-BY IF AMB PROBE > SET AMB. (B); MODULE SE H2O> SET H2O;
HEATING + SANITARY	HEALTH CALL	ON	01 (AMB.)	WINTER	ON IF H2O > PARAM.25	MODULE IF PROBE H2O> 80 ° C
HEATING + SANITARY	SANITARY DOES NOT CALL	OFF	02 (H2O)	WINTER	ON IF H2O > PARAM.25	MODULE IF PROBE H2O> 5ET H20 (a)
HEATING + SANITARY	HEALTH CALL	OFF	02 (H2O)	WINTER	ON IF H2O > PARAM.25	MODULE IF PROBE H2O> 80 ° C
HEATING + SANITARY	SANITARY DOES NOT CALL	ON	02 (H2O)	WINTER	ON IF H2O > PARAM.25	STAND-BY IF PROBE H2O> SET H20 (a)
HEATING + SANITARY	HEALTH CALL	ON	02 (H2O)	WINTER	ON IF H2O > PARAM.25	MODULE IF PROBE H2O> 80 ° C
HEATING + SANITARY	SANITARIO NON CHIAMA	OFF	03 (TERM. ES.)	WINTER	ON IF H2O > PARAM.25	MODULE SE TERM. ES. SATISFIED OR IF H2O PROBE> SET H20 (a)
HEATING + SANITARY	HEALTH CALL	OFF	03 (TERM. ES.)	WINTER	ON IF H2O > PARAM.25	MODULE SE PROBE H2O> 80 ° C
HEATING + SANITARY	SANITARY DOES NOT CALL	ON	03 (TERM. ES.)	WINTER	ON IF H2O > PARAM.25	STAND-BY TERM. ES. SATISFIED; MODULE SE H2O> SET H2O; (B)
HEATING + SANITARY	HEALTH CALL	ON	03 (TERM. ES.)	WINTER	ON IF H2O > PARAM.25	MODULE IF PROBE H2O> 80 ° C
HEATING + SANITARY	SANITARY DOES NOT CALL	OFF	ONLY 2 (H2O)	SUMMER	ON IF H2O > PARAM.25	STAND-BY IF H2O PROBE> SET FORWARD STAND-BY IN (a)
HEATING + SANITARY	HEALTH CALL	OFF	ONLY 2 (H2O)	SUMMER	ON IF H2O > PARAM.25	MODULE SE PROBE H2O> 80 ° C
HEATING + SANITARY	SANITARY DOES NOT CALL	ON	ONLY 2 (H2O)	SUMMER	ON IF H2O > PARAM.25	STAND-BY IF PROBE H2O> SET H20 (a)
HEATING + SANITARY	HEALTH CALL	ON	ONLY 2 (H2O)	SUMMER	ON IF H2O > PARAM.25	MODULE IF PROBE H2O> 80 ° C

Diagram 01: the boiler is connected to a domestic hot water tank and to the heating circuit.

The boiler is switched off when the contact (thermostat) is satisfied. The boiler is switched on when the contact (thermostat) detects a temperature below SET ACS - ΔT (ΔT can be set by technical parameters).

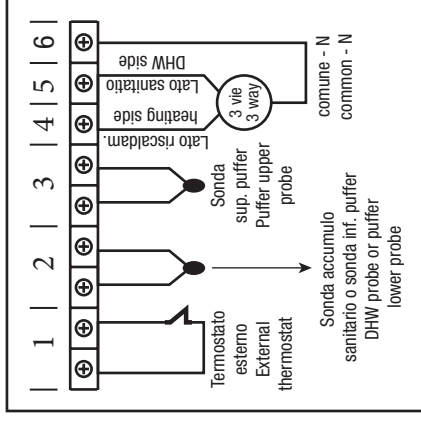
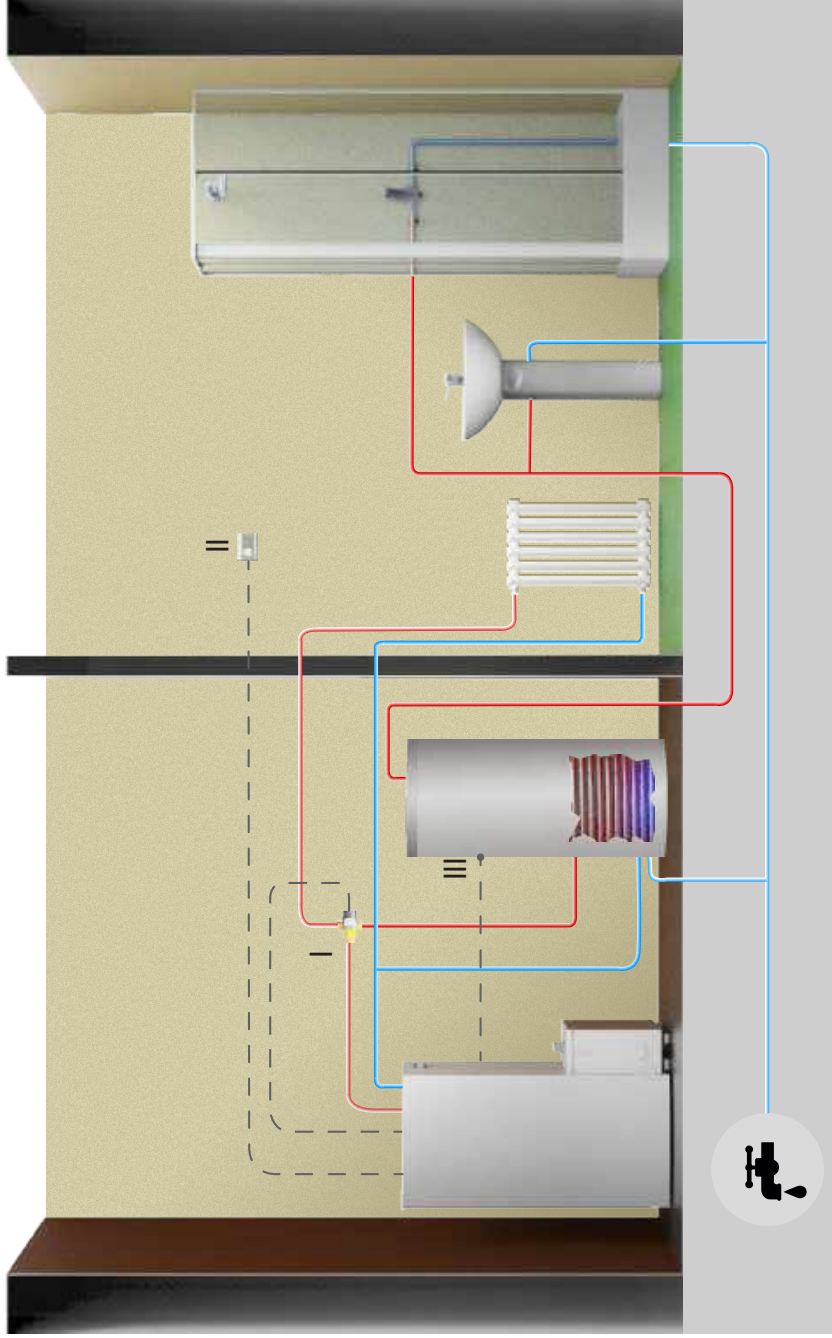

- I = Valve motorization (4-5-6)
- II = External thermostat On / OFF for stand-by type 3 (optional) (1)
- III = ON / OFF thermostat on DHW tank (2)

the scheme is indicative and wants to demonstrate only the components that can be managed by the boiler. Any relay pumps must be controlled separately from the boiler

- a) To set the water temperature in the boiler, press the key. Increase or decrease degrees with keys and .
- b) To set the desired temperature in the room (using the probe on the board) press the key. Increase or decrease degrees with keys and .
- c) To set the work power press the key and adjust it with the and keys.

The rinsing from the stand-by state occurs automatically when a heat increase is required to return to satisfy the chosen stand-by condition (when this is set to ON) or when there is a health risk.

hydraulic scheme		stand-by	stand-by type	season	boiler circulator status	boiler status
HEATING + SANITARY	SANITARY DOES NOT CALL	OFF	01 (AMB.)	WINTER	ON IF H2O > PARAM.25	MODULE IF PROBE H2O> SET H2O (a) OR IF AMB PROBE. > AIR SET (b)
HEATING + SANITARY	HEALTH CALL	OFF	01 (AMB.)	WINTER	ON IF H2O > PARAM.25	MODULE IF PROBE H2O> 80 ° C
HEATING + SANITARY	SANITARY DOES NOT CALL	ON	01 (AMB.)	WINTER	ON IF H2O > PARAM.25	STAND-BY IF AMB PROBE > SET AMB. (B); MODULE SE H2O> SET H2O;
HEATING + SANITARY	HEALTH CALL	ON	01 (AMB.)	WINTER	ON IF H2O > PARAM.25	MODULE IF PROBE H2O> 80 ° C
HEATING + SANITARY	SANITARY DOES NOT CALL	OFF	02 (H2O)	WINTER	ON IF H2O > PARAM.25	MODULE IF PROBE H2O> SET H2O (a)
HEATING + SANITARY	HEALTH CALL	OFF	02 (H2O)	WINTER	ON IF H2O > PARAM.25	MODULE IF PROBE H2O> 80 ° C
HEATING + SANITARY	SANITARY DOES NOT CALL	ON	02 (H2O)	WINTER	ON IF H2O > PARAM.25	STAND-BY IF PROBE H2O> SET H2O (a)
HEATING + SANITARY	HEALTH CALL	ON	02 (H2O)	WINTER	ON IF H2O > PARAM.25	MODULE IF PROBE H2O> 80 ° C
HEATING + SANITARY	SANITARIO NON CHIAMA	OFF	03 (TERM. ES.)	WINTER	ON IF H2O > PARAM.25	MODULE SE TERM. ES. SATISFIED OR IF H2O PROBE> SET H2O (a)
HEATING + SANITARY	HEALTH CALL	OFF	03 (TERM. ES.)	WINTER	ON IF H2O > PARAM.25	MODULE SE PROBE H2O> 80 ° C
HEATING + SANITARY	SANITARY DOES NOT CALL	ON	03 (TERM. ES.)	WINTER	ON IF H2O > PARAM.25	STAND-BY TERM. ES. SATISFIED; MODULE SE H2O> SET H2O; (B)
HEATING + SANITARY	HEALTH CALL	ON	03 (TERM. ES.)	WINTER	ON IF H2O > PARAM.25	MODULE IF PROBE H2O> 80 ° C
HEATING + SANITARY	SANITARY DOES NOT CALL	OFF	ONLY 2 (H2O)	SUMMER	ON IF H2O > PARAM.25	STAND-BY IF H2O PROBE> SET FORWARD STAND-BY IN (a)
HEATING + SANITARY	HEALTH CALL	OFF	ONLY 2 (H2O)	SUMMER	ON IF H2O > PARAM.25	MODULE SE PROBE H2O> 80 ° C
HEATING + SANITARY	SANITARY DOES NOT CALL	ON	ONLY 2 (H2O)	SUMMER	ON IF H2O > PARAM.25	STAND-BY IF PROBE H2O> SET H2O (a)
HEATING + SANITARY	HEALTH CALL	ON	ONLY 2 (H2O)	SUMMER	ON IF H2O > PARAM.25	MODULE IF PROBE H2O> 80 ° C

Diagram 01: the boiler is connected to a domestic hot water tank and to the heating circuit. The boiler is switched off when the contact (thermostat) is satisfied. The boiler is switched on when the contact (thermostat) detects a temperature below SET ACS - ΔT (ΔT can be set by technical parameters).

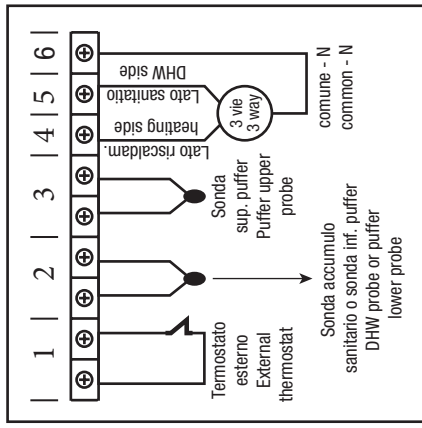
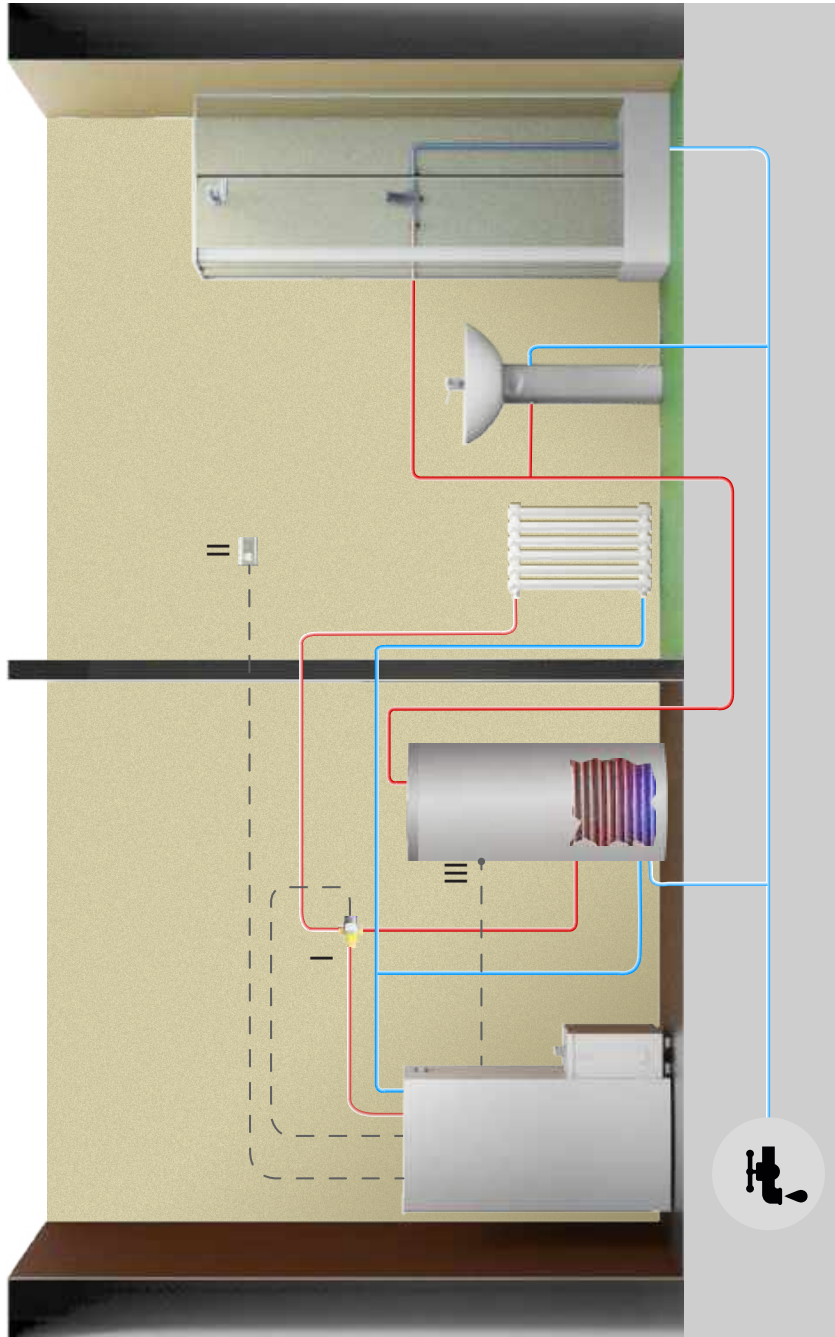

- I = Valve motorization(4-5-6)
- II = External thermostat On / OFF for stand-by type 3 (optional) (1)
- III = ON / OFF thermostat on DHW tank (2)

the scheme is indicative and wants to demonstrate only the components that can be managed by the boiler. Any relay pumps must be controlled separately from the boiler

- a) To set the water temperature in the boiler, press the key. Increase or decrease degrees with keys and .
- b) To set the desired temperature in the room (using the probe on the board) press the key. Increase or decrease degrees with keys and .
- c) To set the work power press the key and adjust it with the and keys.

The rinsing from the stand-by state occurs automatically when a heat increase is required to return to satisfy the chosen stand-by condition (when this is set to ON) or when there is a health risk.

			stand-by	tipo stand-by	stagione	stato circolatore Termo- stufa	stato Termostufa
WINTER							
HEATING + ACS IN CONTACT	SANITARY IN CALL	OFF	01 (AMB.)	WINTER	ON IF H2O > PARAM.25	MODULE IF PROBE H2O> SET H2O (a); IF AMB PROBE > AIR SET (b)	
HEATING + ACS IN CONTACT	SANITARY IN CALL	OFF	01 (AMB.)	WINTER	ON IF H2O > PARAM.25	MODULE IF PROBE H2O> 80 ° C	
HEATING + ACS IN CONTACT	SANITARY IN CALL	ON	01 (AMB.)	WINTER	ON IF H2O > PARAM.25	MODULE SE H2O> SET H2O; (a) STAND-BY IF AMB PROBE. > SET AMB. ; (B)	
HEATING + ACS IN CONTACT	SANITARY IN CALL	ON	01 (AMB.)	WINTER	ON IF H2O > PARAM.25	MODULE IF PROBE H2O> 80 ° C	
HEATING + ACS IN CONTACT	SANITARY IN CALL	OFF	02 (H2O)	WINTER	ON IF H2O > PARAM.25	MODULE IF PROBE H2O > SET H2O (a)	
HEATING + ACS IN CONTACT	SANITARY IN CALL	OFF	02 (H2O)	WINTER	ON IF H2O > PARAM.25	MODULE IF PROBE H2O > 80°C	
HEATING + ACS IN CONTACT	SANITARY IN CALL	ON	02 (H2O)	WINTER	ON IF H2O > PARAM.25	STAND-BY IF PROBE H2O > SET H2O (a)	
HEATING + ACS IN CONTACT	SANITARY IN CALL	ON	02 (H2O)	WINTER	ON IF H2O > PARAM.25	MODULE IF PROBE H2O > 80°C	
HEATING + ACS IN CONTACT	SANITARY IN CALL	OFF	03 (TERM. ES.)	WINTER	ON IF H2O > PARAM.25	MODULE IF EXTERNAL THERMOSTAT SA- TISFIED OR IF PROBE H2O> SET H2O (a)	
HEATING + ACS IN CONTACT	SANITARY IN CALL	OFF	03 (TERM. ES.)	WINTER	ON IF H2O > PARAM.25	MODULE IF PROBE H2O > 80°C	
HEATING + ACS IN CONTACT	SANITARY IN CALL	ON	03 (TERM. ES.)	WINTER	ON IF H2O > PARAM.25	STAND-BY EXTERNAL THERMOSTAT SATISFIED; MODULE IF H2O> SET H2O; (to)	
HEATING + ACS IN CONTACT	SANITARY IN CALL	ON	03 (TERM. ES.)	WINTER	ON IF H2O > PARAM.25	MODULE IF PROBE H2O > 80°C	
HEATING + ACS IN CONTACT	TERM. SAN. NOT IN CALL	OFF	01/02/03	SUMMER	ON IF H2O > PARAM.25	STAND-BY IF PROBE H2O > SET H2O (a)	
HEATING + ACS IN CONTACT	TERM. SAN. NOT IN CALL	OFF	01/02/03	SUMMER	ON IF H2O > PARAM.25	MODULE IF PROBE H2O > 80°C	
HEATING + ACS IN CONTACT	TERM. SAN. NOT IN CALL	ON	01/02/03	SUMMER	ON IF H2O > PARAM.25	STAND-BY IF PROBE H2O > SET H2O (a)	
HEATING + ACS IN CONTACT	TERM. SAN. NOT IN CALL	ON	01/02/03	SUMMER	ON IF H2O > PARAM.25	MODULE IF PROBE H2O > 80°C	

Accensione Caldaia



Remove any components which might burn from the firebox and from the glass (various instructions and adhesive labels)

Charge pellet

Fuel is loaded from the upper part of the boiler by opening a door. Pour the pellets in the hopper. When empty, this is easier if performed in two steps:

- Pour half of the contents of the bag into the hopper and wait for the fuel to settle on the bottom.
- Then pour in the rest.





Never remove the protection grille in the hopper. When filling, do not let the sack of pellets touch any hot surfaces.



The brazier should be cleaned before each starting.

Control Panel (Fig. 2)



Button  is used to switch on and / or off the boiler and to exit programming.

Buttons  are used to adjust temperature, for displays and for the programming functions.

Buttons  are used to adjust heating power.

Button  is used to adjust temperature and programming functions.

The upper and lower displays are used to view different messages.

LED	SIMBOLO	DESCRIZIONE
1		The LED is on when the parameter UT01 on the menu is not on OFF and the weekly or daily programming are set.
2		The LED starts up every time the boiler is loading pellets
3		The LED blinks when the board signals a change in temperature or power set by the infrared remote control.
4		The LED is on when the room temperature reaches the value set on the menu SET Water.
5	SET	The LED blinks to indicate that you are entering the menu user/technician or that you are modifying the temperature set.
6		The LED switches on when the water circulator is working.



It is advisable to use dry wood pellets, up to 6 mm in diameter.

Preliminary checks

Before switching on the pellet boiler, make sure that the pellet hopper is full, the combustion chamber is clean, the glass door is closed, the power supply plug is connected and the switch on the back is set to "1."

Informazioni sul display



TURNED OFF

The boiler is off.



TURNED ON

The stove is in the first ignition phase.
The glow plug and fume extractor are active.

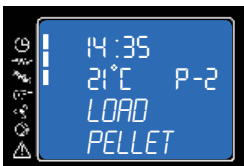

LOAD PELLETT

In this phase of the ignition process the stove starts loading the pellets into the brazier.
The glow plug, the fume extractor and the cochlea engine are active.



FIRE PRESENT

In this phase of the ignition process the stove starts loading the pellets into the brazier.
The fume extractor and the cochlea engine are active.



WORK

The stove is working, in this case at power 3.
The detected room temperature is 21 ° C. During normal work, the fumes fan, the auger motor and the room fan are active.

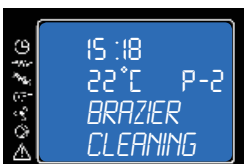

BRAZIER CLEANING

The stove is cleaning the basket.
The smoke extractor runs at maximum speed and the pellet load is at minimum.

Alarm signals

In the event of a working defect, the system informs the user about the type of failure occurred. The following table summarises the alarms, kind of problem and possible solution:

Display Superiore	Lower Display	Kind of failure	Solution
ALAR	NO LIGHTIN-	The boiler cannot start up This is the first light-up	Fill in the tank with pellets Start up again
ALAR	NO FIRE	The pellet boiler switched off while working	Fill in the tank with pellets
ALAR	SOND FUMI	The smokes sensor is broken or not connected to the pcb	Contact an Authorized Assistance Center
ALAR	HOT H2O	The water temperature exceeds 90°C. The circulating pump is blocked or there is no water in the hydraulic system	Check the power supply on the pump. Check limestone does not block the pump impeller
ALAR	SOND H2O	The water sensor is not connected There is a short circuit on the water sensor	Check the water sensor is connected Contact an Authorized Assistance Center
ALAR	HOT TEMP	The smokes temperature exceeds 280°C	Smokes sensor failure Contact an Authorized Assistance Center
COOL	FIRE	There is no power supply	As soon as the power supply is back, the boiler starts a cooling cycle. After completing the cycle it starts working automatically
ALAR	FAN FAIL	Smokes extractor blocked or broken	Contact an Authorized Assistance Center
ALAR	DEP FAIL	Obstructed flue	Clean the flue or check there are no obstructed grids near the smokes exhaust
ALAR	SIC FAIL	Pellets tank overheating	Re-set the safety thermostat for pellets on the back of the boiler. If the problem occurs again, contact an Authorized Assistance Center
ALAR	PRESS	The system pressure does not reach 0,5 bar or exceeds 2,3 bar	Reduce the system pressure Charge the system
ALAR	NO NETWORK	Absence power supply	The return of electricity to restart the stove
SERV		The boiler has worked for 1300 hours. Supplementary maintenance required	Contact an Authorized Assistance Center

Regular checks should be carried out by the user, who should only contact the Authorized Assistance Center if no solution is found.

GB Menù programmazione

Menu 02 SET CLOCK

To access the set clock option, press the "SET" button (3), with the button - (5) scroll through the submenus until MENU 02 - SET CLOCK and with buttons 1 and 2 select the current day. Press the "SET" button (3) to confirm.

Then use buttons 1 and 2 to set the time and press "SET" (3) to advance to the minutes setting by pressing buttons 1 and 2. By pressing set again it's possible to access various submenus in order to set the date, day, month, and year. To do so, repeat the steps indicated above, using buttons 1, 2, and 3.

The following table briefly describes the structure of the menu, focusing only on those selections which are available to the user.

level 1	level 2	level 3	level 4	value
02 - set clock				
	01 - day			day of the week
	02 - hour			hour
	03 - minutes			minutes
	04 - day			day of the month
	05 - month			month
	06 - year			year

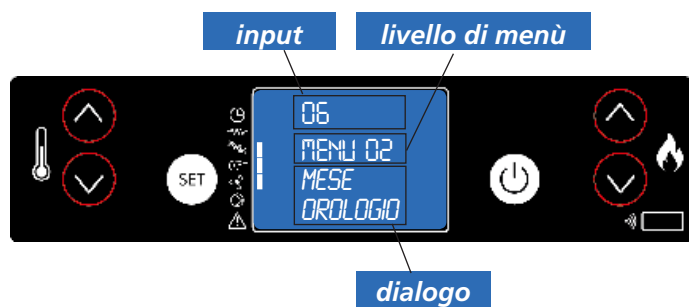

Set the current time and date. The device comes equipped with a lithium battery that allows the internal clock to operate autonomously for over 3-5 years.

Menu 03 SET CHRONO

Press the "SET" button (3) and then button 5 to arrive at the desired menu; press "SET" (3) to enter.

Enter menu M-3-1 and with buttons 1 and 2 select whether or not to activate the thermostat (on/off), which allows you to program the automatic ignition of the stove.

Once the thermostat is activated/deactivated, press button "4" (OFF) and continue scrolling through the submenus using button 5. Select which submenu you wish to enter in order to access the daily, weekly, and weekend programmes.

To set the ignition times and days repeat the previous steps:

- access the submenu using "SET" (3)
- adjust the days, times, and activation status (on/off) with buttons 1 and 2
- confirm by pressing the "SET" button (3)
- exit from the submenu/menu with button 4 to turn it off

The following table briefly describes the structure of the menu, focusing only on those selections which are available to the user.

livello 1	livello 2	livello 3	livello 4	valore
03 - set crono				
	01 - abilita crono			
		01 - abilita crono		on/off
	02 - program. giorno			
		01 - crono giorno		on/off
		02 - start 1 giorno		ora
		03 - stop 1 giorno		ora
		04 - start 2 giorno		ora
		05 - stop 2 giorno		ora

level 1	level 2	level 3	level 4	value
03 - set thermostat				
	01 - activate thermos.			
		01 - activate thermos.		on/off
	02 - day programme			
		01 - daily thermostat		on/off
		02 - start 1 day		hour
		03 - stop 1 day		hour
		04 - start 2 day		hour
		05 - stop 2 day		hour
	03 - week program.			
		01 - week thermostat		on/off
		02 - start program. 1		hour
		03 - stop program. 1		hour
		04 - monday progr. 1		on/off
		05 - tuesday progr. 1		on/off
		06 - wednesday prog. 1		on/off
		07 - thursday prog 1		on/off
		08 - friday prog 1		on/off
		09 - saturday prog 1		on/off
		10 - sunday prog 1		on/off
		11 - start program. 2		hour
		12 - stop program. 2		hour
		13 - monday progr. 2		on/off
		14 - tuesday progr. 2		on/off
		15 - wednesday prog. 2		on/off
		16 - thursday prog 2		on/off
		17 - friday prog 2		on/off
		18 - saturday prog 2		on/off
		19 - sunday prog 2		on/off
		20 - start program. 3		hour
		21 - stop program. 3		hour
		22 - monday progr. 3		on/off
		23 - tuesday progr. 3		on/off
		24 - wednesday prog. 3		on/off
		25 - thursday prog 3		on/off
		26 - friday prog 3		on/off
		27 - saturday prog 3		on/off
		28 - sunday prog 3		on/off
		29 - start program. 4		hour
		30 - stop program. 4		hour
		31 - monday progr. 4		on/off
		32 - tuesday progr. 4		on/off
		33 - wednesday prog. 4		on/off
		34 - thursday prog. 4		on/off

		35 - friday prog. 4		on/off
		36 - saturday prog. 4		on/off
		37 - sunday prog. 4		on/off
	04 - week-end program.			
		01 - therm. week-end		
		02 - start 1		
		03 - stop 1		
		04 - start 2		
		05 - stop 2		

Menu 03 SET CHRONO

Submenu 03 - 01 - activate thermostat

This allows you to activate and deactivate all of the functions of the thermostat

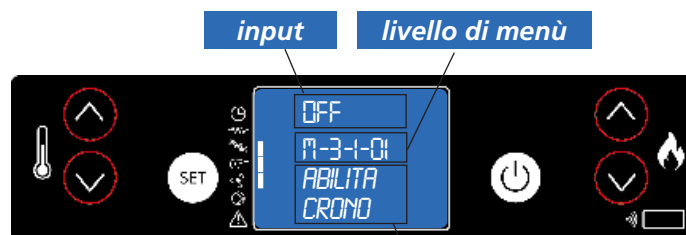

Submenu 03 - 02 - daily programme

This allows you to enable, disable, and set the daily functions of the thermostat.



It's possible to set two operating ranges delimited by the times set according to the following table where the OFF setting tells the clock to ignore the command:

selezione	significato	valori possibili
START 1	ora di attivazione	ora - OFF
STOP 1	ora di disattivazione	ora - OFF
START 2	ora di attivazione	ora - OFF
STOP 2	ora di disattivazione	ora - OFF

Submenu 03 - 03 - weekly programme

This allows you to enable, disable, and set the weekly functions of the thermostat.

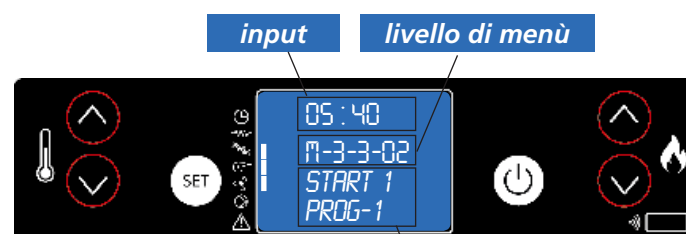

The weekly programmer has 4 independent programmes whose final effect is composed of the combination of the 4 individual programmes. The weekly programmer can be activated or deactivated. Additionally, by setting OFF in the time field, the clock ignores the corresponding command.



Plan programming carefully in order to avoid overlapping activation/deactivation times in a single day in different programmes.

PROGRAMME 1			
menu level	selection	meaning	possible values
02-03-02	START PROGRAM 1	activation time	time - OFF
02-03-03	STOP PROGRAM 1	shut-off time	time - OFF
02-03-04	MONDAY PROGRAM 1	reference day	on/off
02-03-05	TUESDAY PROG 1		on/off
02-03-06	WEDNESDAY PROG 1		on/off
02-03-07	THURSDAY PROGR 1		on/off
02-03-08	FRIDAY PROGRAM 1		on/off
02-03-09	SATURDAY PROGR 1		on/off
02-03-10	SUNDAY PROGR 1		on/off

PROGRAMME 2			
menu level	selection	meaning	possible values
03-03-11	START PROGRAM 2	activation time	time - OFF
03-03-12	STOP PROGRAM 2	shut-off time	time - OFF
03-03-13	MONDAY PROGRAM 2	reference day	on/off
03-03-14	TUESDAY PROG 2		on/off
03-03-15	WEDNESDAY PROG 2		on/off
03-03-16	THURSDAY PROGR 2		on/off
03-03-17	FRIDAY PROGRAM 2		on/off
03-03-18	SATURDAY PROGR 2		on/off
03-03-19	SUNDAY PROGR 2		on/off

PROGRAMME 3			
menu level	selection	meaning	possible values
03-03-20	START PROGRAM 3	activation time	time - OFF
03-03-21	STOP PROGRAM 3	shut-off time	time - OFF
03-03-22	MONDAY PROGRAM 3	reference day	on/off
03-03-23	TUESDAY PROG 3		on/off
03-03-24	WEDNESDAY PROG 3		on/off
03-03-25	THURSDAY PROGR 3		on/off
03-03-26	FRIDAY PROGRAM 3		on/off
03-03-27	SATURDAY PROGR 3		on/off
03-03-28	SUNDAY PROGR 3		on/off

PROGRAMME 4			
menu level	selection	meaning	possible values
03-03-29	START PROGRAM 4	activation time	time - OFF
03-03-30	STOP PROGRAM 4	shut-off time	time - OFF
03-03-31	MONDAY PROGRAM 4	reference day	on/off
03-03-32	TUESDAY PROG 4		on/off
03-03-33	WEDNESDAY PROG 4		on/off
03-03-34	THURSDAY PROGR 4		on/off
03-03-35	FRIDAY PROGRAM 4		on/off
03-03-36	SATURDAY PROGR 4		on/off
03-03-37	SUNDAY PROGR 4		on/off

Submenu 03 - 04 - program week-end

This allows you to enable, disable, and set the weekend functions of the thermostat (days 5 and 6, or Saturday and Sunday).

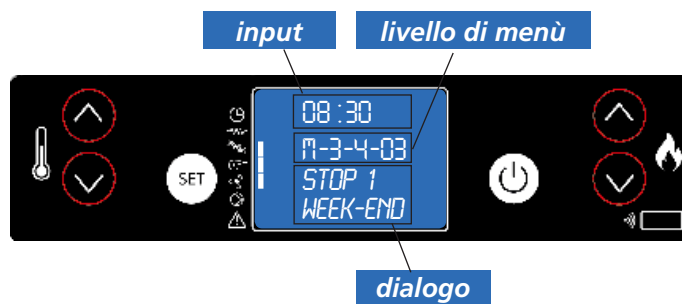

REMARKS:

- in order to avoid confusion and unwanted start-ups or shutdowns, activate only one programme at a time unless you know exactly what you'd like to achieve
- deactivate the daily program if you want to use the weekly program
- always leave the weekend programme deactivated if you use weekly programmes 1, 2, 3, and 4.
- activate the weekend programme only after you have deactivated the weekly programme.

Menu 04 - select language

Press the SET button to access the menu and press (5) up to the MENU 04 - SELECT LANGUAGE. Then press the SET button to access the menu. Select the desired language using the keys (1) e (2)

Failed light-up

If the flame does not light up during the switching on or if the smokes temperature does not reach a suitable value in the foreseen time gap, the boiler switches off and you will read the words **ALAR NO ACC** on the display. Press the key "On/Off" to reset the alarm. Wait until the cooling phase is completed, clean the brazier and start a new light-up.

Switching off while working

The boiler suddenly switches off while working (for example because it has run out of pellets in the tank or because the motor reducer for pellets loading got broken). The boiler continues working until the pellets left in the brazier ends. You will then read the words "**ALAR NO FIRE**" on the display and the boiler switches off. Press the key "On/Off" to reset the alarm. Wait until the cooling phase is completed. Clean the brazier and start a new light-up.

These alarms remind you that the brazier must be cleaned and installed correctly before switching on the boiler.

There is no power supply

In the event of a power drop longer than one minute, the boiler can exhaust some smoke in the room: this causes no risks. As soon as you have the power supply again, the boiler will have the words "**COOL FIRE**" on the display. After completing the cooling phase, the boiler will start up again automatically according to the previous settings.



Do not attempt to start the boiler before the required time or it may get blocked. If this occurs, switch off the switch on the back of the pellet boiler for 1 minute, set it on again and wait 10 minutes before starting the boiler again.



The power socket where the boiler is connected should be fitted with "earth connection complying with regulations in force." The Manufacturer shall not be held responsible for damage to things or people resulting from negligent installation.

Manual restart thermostat

System pressure safety

The system pressure is checked electronically and needs to be between 0,5 and 2,3 bar. If this is not the case, the pellet boiler signalises an alarm and shows the words "**ALAR PRESS**" on the display.

Press" on the display. Check the system pressure keeping the key pressed for some seconds. You will read the bar value on the display.

The safety valve keeps anyway the value under 2,5 bar letting the exceeding water flow out automatically.



Water Characteristics

The characteristics of the water used to fill the system are very important to prevent the build-up of mineral salts and the formation of incrustations along the pipes, in the boiler and in the heat exchangers.

Therefore, please get your plumber's advice concerning:

- Hardness of water circulating in the system, to prevent problems of incrustation and limescale, especially in the domestic water heat exchanger (>25° French).
- Installation of a water softener (if water hardness > 25° French).
- Filling the system with treated water (demineralised).

If you have very extensive system, with a large amount of water, or which require frequent refilling, it is recommended the installation of water softening system. It 'should be noted that the encrustations drastically reduce performance because of their low thermal conductivity.

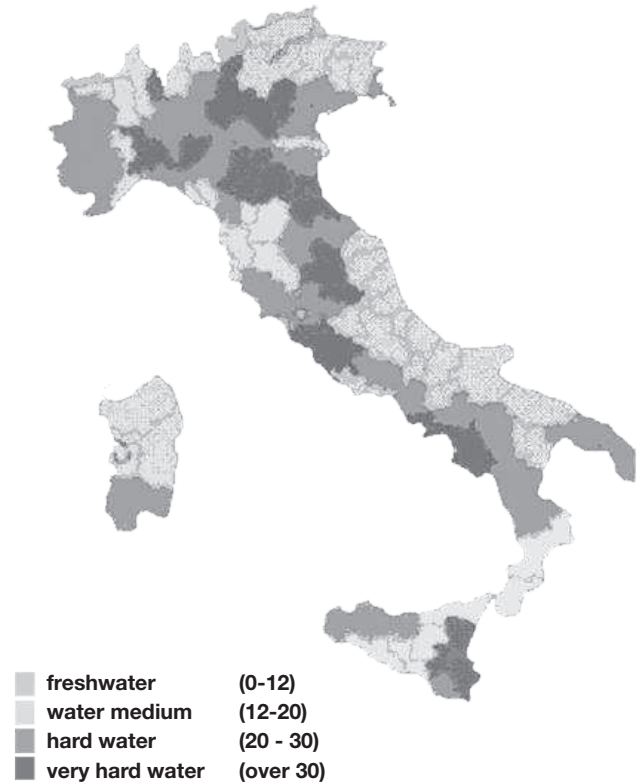



Pressure switch: monitors depression in the smoke duct. It is designed to shut down the pellet feed screw in the event of an obstructed flue or significant back-pressure in the presence of wind. At the time of the pressure switch will show **"ALAR-DEP-FAIL"**.

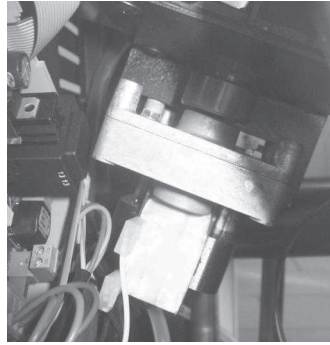

Reduction motor: if the motor stops, the thermostove continues to function until the flame goes out for lack of fuel, and until it has cooled down to the minimum level.

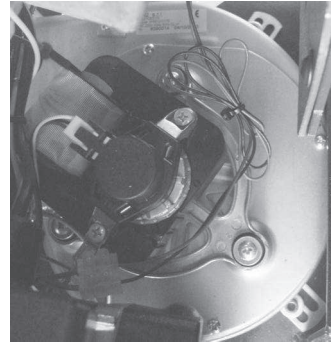

Flue gas temperature sensor: thermocouple that measures the temperature of the fumes while keeping the operation or shuts the thermostove when the flue gas temperature drops below the preset value.



Electrical safety: the stove is protected against violent surges of current (ex. lightnings) by the main fuse 4 A which is located on the control panel at the rear of the thermostove. Other fuses to protect the electronic boards are to be found on the boards themselves.

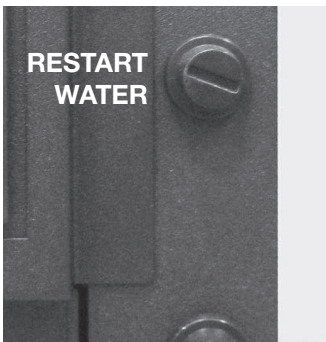

Safety thermostat with manual reset for the water temperature: if the temperature of the water tank exceeds the preset safety level of 100 °C immediately stops the operation of the thermostove and the display will show **"ALAR-SIC-FAIL"**. To restart you need to reset manually.



Pellets temperature safety: In the rare event there is a too high temperature in the tank, the thermostat for pellets safety with manual reset creates an alarm **"ALAR-SIC-FAIL"** stopping the pellet boiler stove. You need to reset the system working on the device placed on the back of the thermostove.

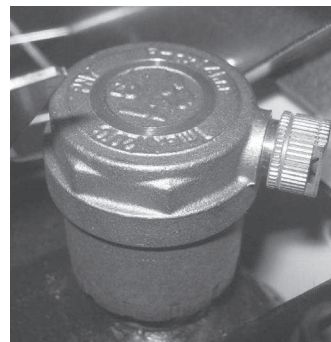

Automatic vent valve: this valve eliminates the air inside the thermostove and of the heating system.

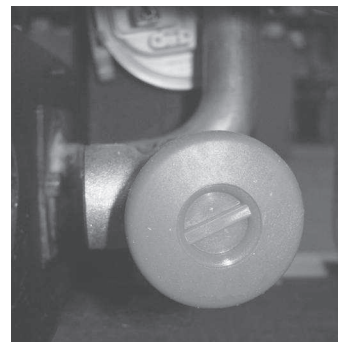

Safety valve: this valve acts to prevent over pressurization of the hydraulic system. If the pressure of the thermostove or plant exceeds 2.5 bar it drains the water from the circuit.



Tampering with the safety devices is prohibited. It is only after eliminating the cause which gave rise to the intervention of the safety system, that it is possible to relight the stove and thus reset the automatic operation of the sensor. To understand which anomaly has occurred, consult this manual at paragraph relating to alarms which explains what to do based on the alarm message the stove display.

Failure on electrical devices

Failed light-up

If the flame does not light up during the switching on or if the smokes temperature does not reach a suitable value in the foreseen time gap, the thermostove switches off and you will read the words **"ALAR NO ACC"** on the display.

Press the key "On/Off" to reset the alarm. Wait until the cooling phase is completed, clean the brazier and start a new light-up.

Switching off while working

The thermostove suddenly switches off while working (for example because it has run out of pellets in the tank or because the motor reducer for pellets loading got broken). The thermostove continues working until the pellets left in the brazier ends. You will then read the words **"ALAR NO FIRE"** on the display and the stove switches off. Press the key "On/Off" to reset the alarm. Wait until the cooling phase is completed. Clean the brazier and start a new light-up.

These alarms remind you that the brazier must be cleaned and installed correctly before switching on the thermostove.

There is no power supply

In the event of a power drop longer than one minute, the thermostove can exhaust some smoke in the room: this causes no risks.

As soon as you have the power supply again, the thermostove will have the words **"COOL FIRE"** on the display. After completing the cooling phase, the thermostove will start up again automatically according to the previous settings.



Do not attempt to start the thermostove before the required time or it may get blocked. If this occurs, switch off the switch on the back of the pellet boiler stove for 1 minute, set it on again and wait 10 minutes before starting the thermostove again.



The power socket where the thermostove is connected should be fitted with "earth connection complying with regulations in force." The Manufacturer shall not be held responsible for damage to things or people resulting from negligent installation.

Manual restart thermostat



System pressure safety

The system pressure is checked electronically and needs to be between 0,5 and 2,3 bar. If this is not the case, the pellet boiler stove signals an alarm and shows the words **"ALAR PRESS"** on the display.

Press the key "On/Off" on the display. Check the system pressure keeping the key  pressed for some seconds. You will read the bar value on the display.

The safety valve keeps anyway the value under 2,5 bar letting the exceeding water flow out automatically.

Intervention in case of danger

In case of fire, disconnect the power supply, use a fire extinguisher in accordance with, and if necessary, call the fire department and then contact an authorised qualified technical assistance

Maintenance and cleaning



All cleaning of all parts must be carried out with the stove completely cold and unplugged to avoid burns and thermal shock. The stove does not need much maintenance if used with certified quality pellet. The need for maintenance varies depending on the conditions of use (switching on and off repeatedly) and depending on the performance required.

Parts	Everyday	Every 2-3 days	Every week	Every 15 days	Every 30 days	Every 60-90 days	Every 1 year
Brazier	◇						
Cleaning the ash collection compartment with suction device		◇					
Cleaning ash tray		◇					
Cleaning the door and glass		◇					
Exchanger (turbulators)	◇						
Cleaning the interior heat exchanger / smoke fan compartment						•	
Cleaning complete exchanger							•
Clean "T" to exhaust						•	
Flue							•
Door gasket ash						•	
Internal parts							•
Flue pipe							•
Circulation pump							•
Plate heat exchanger							•
Hydraulic components							•
Electromechanical components							•

◇ by the user



• by the authorised qualified technical assistance

BY THE USER

Daily control

The thermostove requires a simple and thorough cleaning in order to ensure a more efficient performance and smooth operation.

While cleaning the inside of the thermostove, to prevent the escape of ashes, you can start the fan flue exhaust.

To enable this feature, you must press the button  and then .

The display shows "PUL STUF" (cleaning thermostove).

To stop the fan, simply press and hold the button  or wait for completion of a cleaning cycle (255 seconds).

Clean the grate using the appropriate tool from the ash and any incrustation which could obstruct the passage of air. In the case of depletion of pellets in the tank may accumulate unburned pellets in the burn pot.

Always empty the residuals from the grate before each start. Remember that only a brazier located and clean properly can ensure ignition

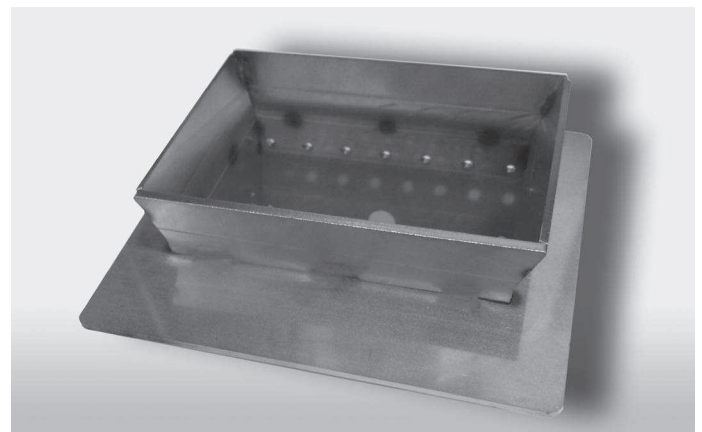

The decreased or absent cleaning can cause misfire and cause damage to the thermostove and the environment (possible emissions of soot and unburned). Do not pour the pellets may be present in the brazier to misfire.

Cleaning battifiamma

The thermostove is provided with two elements in vermiculite: the bottom of the combustion chamber and the battifiamma.

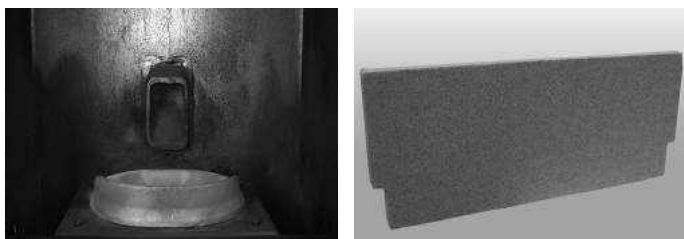

Vermiculite is a mineral from a variety of uses in industry and construction for its insulating properties, thermal and acoustic properties. In this case, the vermiculite is used to avoid unnecessary heat dispersions. Because of its fragility, it is recommended to handle with extreme care battifiamma during the cleaning of the combustion chamber and clean it only with a soft, dry cloth.

Shutting the thermostove down

In the period when the thermostove is out of use it must be disconnected from the electricity mains. For greater safety, especially if there are children around, we recommend removing the power cable from the rear of the thermostove.

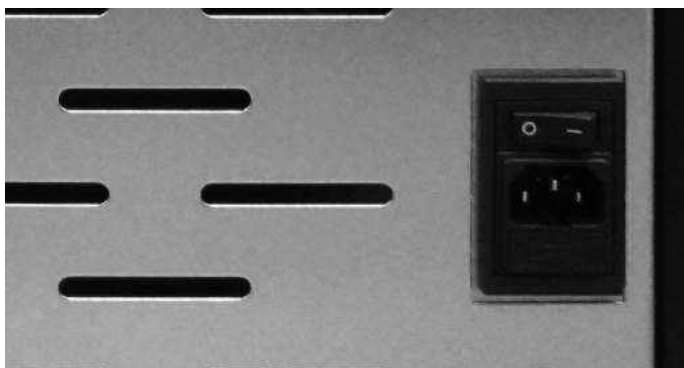

Before placing the thermostove in storage, you should remove all pellets from the hopper with a vacuum cleaner with a long extension. If the fuel is left in the hopper, it may get damp, stick together, and be difficult to light at the beginning of the next season.

If pressing the main switch (located on the back of the stove) does not make the control panel display light up, it could mean that the service fuse needs replacing.

On the rear of the stove there is a fuse holding compartment which is located underneath the supply socket. With a screwdriver open the cover of the fuse holding compartment, and replace the fuse if necessary (3,15 AT delayed type). Plug the unit back in and press the main switch.

CLEANING BY THE TECHNICAL

Check every year

Compartment ventilation flue gas cleaning

Remove the fixing screws and remove the smoke fan for cleaning of the same. Perform the task with the greatest care not to bend the fan blades.

Clean flue

Clean the flue system especially near the fittings to "T", curves and any horizontal sections. Is necessary to check and remove any deposit of ash and soot before the same clogging the passage of smoke.

Cleaning the exchanger

Once a year is also recommended to clean the upper compartment of the exchanger. To make a proper cleaning is recommended to suck the ash, remove all horizontal joints with a screwdriver, then again suck the ash.

Lift the upper door that covers the tube by unscrewing the screws. Pull out the 10 soft brush and wipe with a clean 10 exchanger tubes.

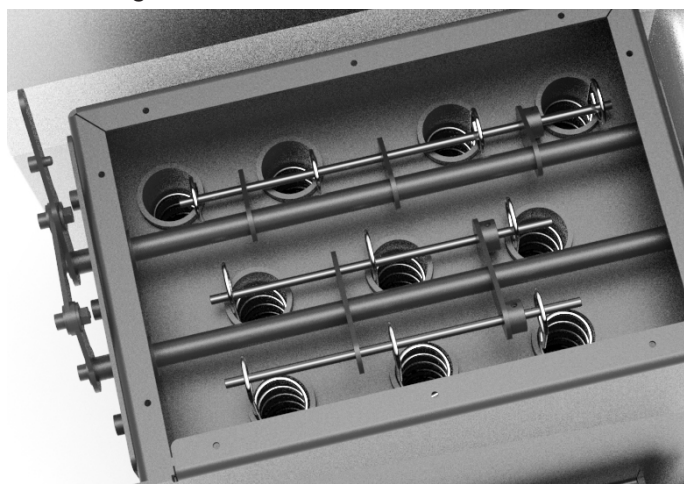

Perform cleaning after removing the springs inserted in each pipe. The operation is simple by removing the springs from the horizontal pin to which they are attached. To do this, the horizontal pin can be pulled through a hole in the wall of the thermostove body.





The transaction must be completed by unscrewing with a screwdriver the fixing bushes (photo 1).

Remove the screws holding the cleaning kit to the camera body and pull it completely (photo 2-3).

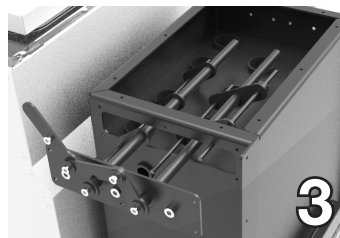

Now the upper section to the heat exchanger is free from any encumbrance so as to allow a perfect cleaning.

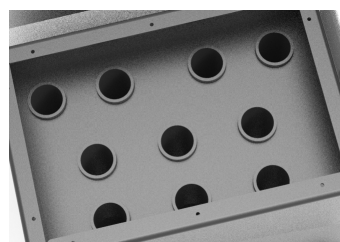

Following the cleaning of the upper compartment of the exchange section, store the upper closure cover. This cover must be closed, as well as with normal screws, with webbing in ceramic fiber rope to ensure the watertight closure of the thermostove.

This general cleaning should be carried out at the end of the season in order to facilitate the general removal of all residues of combustion, without waiting too long, because with time and humidity these residues can become compacted.

Check the seal of the ceramic fiber gaskets on the door of the thermostove.

Then clean the flue system especially near the fittings to "T" and any horizontal sections.



For your safety, the frequency of cleaning the smoke discharge system must be determined on the basis of how the thermostove is used.

In case of failure or inadequate cleaning of the heater may have function problems such as:

- poor combustion
- blackening of the glass
- clogging of grate with accumulation of ash and pellets
- ash deposit and excessive deposits on the heat exchanger resulting in poor performance.

The check of electromechanical components must be performed only by qualified personnel with technical knowledge of electricity and combustion.

We recommend that an annual maintenance service is carried out, preferably under a programmed service contract. The essential part of this service is a visual and functional check on the following components:

- reduction motor
- smoke expulsion fan
- smoke sensor
- heat-exchanger fan
- ignition sparkplug
- resettable pellet thermostat
- room temperature sensor
- pressostat
- motherboard
- fuse protecting panel - motherboard



These operations must be performed by a qualified technician, or the user who will take responsibility in the event of damage during maintenance.

Perform this maintenance heater cold and in the absence of electricity. If such maintenance is performed by an authorized service center is the responsibility of the customer.

Surface cleaning

The thermostove is a product by heating, presents the external surfaces particularly hot.

For this reason, we recommend extreme caution when operating in particular:

- Do not touch the thermostove body and the various components, do not approach the door, it could cause burns;
- Do not touch the exhaust fumes;
- Do not perform any type of cleaning;
- Do not dump the ashes;
- Do not open the ash tray;
- Be careful that children do not come close.

All cleaning of all parts must be carried out with the stove completely cold and the plug disconnected.

To clean the surfaces, use a rag dampened with water or with water and a neutral detergent.



The use of aggressive detergents or thinners can damage the surfaces of the thermostove. Before using any detergent it is advisable to try it on a small section out of sight or contact the Authorized Assistance Centre for information regarding the product.

Warnings for cleaning

All cleaning of all parts must be carried out with the stove completely cold and the plug disconnected.

Before effecting any maintenance operation or cleaning on the stove, take the following precautions:

- be sure that all parts of the stove are cold
- be sure that the ashes are completely cold;
- be sure that the general switch is in the “OFF” position;
- be sure that the plug is pulled out of the socket to avoid accidental contact;
- Once the maintenance phase is completed check that everything is in order as per before the intervention (the brazier is placed correctly).

Any kind of tampering or unauthorized substitution of non-original of the thermostove can be hazardous to the safety of the operator and relieves the manufacturer from any civil or criminal liability. Use only original spare parts. Replace a worn before failure promotes the prevention of injuries resulting from accidents caused by the sudden failure of the components.



After 1300 hours of operation of the heater will appear on the lower display the word “SERV”, please contact your Authorized Service Center for cleaning and routine maintenance.



Follow carefully the following cleaning instructions. Failure to follow these instructions could create problems with the operation of the thermostove.

Problems and solutions



All repairs must be carried out exclusively by a specialised technician, with the stove completely cold and the electric plug pulled out. Is prohibited from any unauthorized modification to the device and the replacement of parts with other non-original. The operations marked in bold type must be carried out by specialised personnel.

Check for proper combustion of the shape and color of the flame

PROBLEM	POSSIBLE CAUSE	REMEDY
The flame thickens at the base and the tip has not pulled upwards.	1. Bad regulation that determines: <ul style="list-style-type: none"> • Too full of pellets • Low fan speed 2. The duct is obstructed or there are pressures that hamper the smooth evacuation of fumes	1. Define the adjustment of the stove 2. Clean the smoke duct and check the pressure switch that measures the proper depression of the chimney
Flame swollen and bursting with color from orange to yellow with dark tips	1. Combustion wrong 2. Flame oxygen deficient	1. Define the adjustment of the stove 2. Make sure the air duct up to the brazier is not obstructed 3. Contact your Authorized Assistance Center

In normal combustion, the flame should have a tapered shape, compact, with character “lively” and with the tips tend to be vertical or crushed towards the back of the firebox. You have to have the feeling that the flame is pulled upwards.

Anomalies related to the scope mechanical or electronic

PROBLEM	POSSIBLE CAUSE	REMEDY
Pellet not being fed into the combustion chamber.	<ol style="list-style-type: none"> 1. Pellet hopper empty 2. Feeder screw blocked by sawdust 3. Reduction motor defective 4. Defective electronic board 5. One of the thermostats with manual reset is triggered 	<ol style="list-style-type: none"> 1. Refill pellet hopper 2. Empty the hopper and manually free the feeder screw of sawdust 3. Replace reduction motor 4. Replace electronic board 5. Reset on the back of the thermostove the safety thermostat after verifying the cause
The stove does not run	<ol style="list-style-type: none"> 1. Plug out of place 2. Lack of electricity supply 3. Parameter suction power to change 4. Pellet or water sensor in lockout 5. Fuse blown 6. Obstruction of nests or foreign bodies in the chimney or fireplace 	<ol style="list-style-type: none"> 1. Check the correct position of the sparkplug in the grate 2. Check that the electric socket is plugged in and that the main switch is in position "I" 3. Contact your Authorized Assistance Center 4. Wait for the cooling of the pellets or water tank and turn on the thermostove 5. Replace the fuse 6. Remove all foreign matter from the chimney or flue outlet of the barrel. It is recommended that the intervention of a chimney sweep
The fire goes out or the stove stops automatically	<ol style="list-style-type: none"> 1. Pellet hopper empty 2. Pellets not being fed in 3. Intervention of pellet temperature sensor 4. Door not closed properly or gaskets worn 5. Boiler temperature is too high 6. Unsuitable pellets 7. Low pellet feed rate 8. Combustion chamber dirty 9. Smoke outlet obstructed 10. Smoke extraction motor failed 11 Pressure switch faulty or defective 	<ol style="list-style-type: none"> 1. Refill pellet hopper <p>If it is first ignition the fuel, having to go the route that goes from the tank to the brazier, may not be able to arrive on time and in the right amount programmed</p> <ol style="list-style-type: none"> 2. If after repeated ignitions did not appear in the flame, even with regular supply of pellets, the problem may be related to the components of the heater or the improper installation 3. Let the stove cool down completely, reset the thermostat till lockout ceases, relight stove; if problem persists, contact technical assistance 4. Close the door or replace the gaskets with original spare parts 5. Check for proper operation of the water pump, if necessary, replace the component 6. Change to a type of pellet recommended by the manufacturer 7. Have the fuel feed rate checked by technical service 8. Clean the combustion chamber, following instructions in the manual 9. Clean the smoke duct 10. Check the motor and replace if necessary 11. Replace the pressure
The stove runs for a few minutes and then goes out.	<ol style="list-style-type: none"> 1. Lighting cycle not completed 2. Temporary failure of electricity supply. 3. Smoke duct obstructed. 4. Temperature sensors defective or broken. 5. Sparkplug failure. 	<ol style="list-style-type: none"> 1. Re-run lighting cycle 2. See previous instruction 3. Clean smoke duct 4. Check and replace sensors as necessary 5. Check the plug and replace if necessary

Pellet build up in grate, door glass gets dirty and flame is weak	<ol style="list-style-type: none"> 1. Insufficient combustion air 2. Pellets damp or unsuitable 3. Smoke extractor motor broken 4. Bad adjustment. Wrong ratio between air and pellet 	<ol style="list-style-type: none"> 1. Check that the room air intake is present and free. Check that the pipe Ø 5 cm for air inlet is not obstructed. Clean the grate and check that all the airways are clear. Carry out a general cleaning of the combustion chamber and the smoke duct. Check the state of the door gaskets 2. Change the type of pellet 3. Check the motor and replace if necessary 4. Contact your Authorized Assistance Center
The smoke extraction motor does not work	<ol style="list-style-type: none"> 1. No electrical supply to the thermostove 2. The motor is broken 3. Defective electronic board 4. Control panel broken 	<ol style="list-style-type: none"> 1. Check the supply voltage and the protection fuse 2. Check the motor and capacitor and replace if necessary 3. Replace electronic board 4. Replace the control panel
The air fan convention never stops	<ol style="list-style-type: none"> 1. Temperature sensor temperature control defective or broken 2. Fan failure 	<ol style="list-style-type: none"> 1. Check operation of the sensor and replace if necessary 2. Check operation of the motor and replace if necessary
In the automatic position the thermostove always runs at full power	<ol style="list-style-type: none"> 1. Room thermostat set to maximum 2. Temperature sensor defective 3. Control panel defective or broken 	<ol style="list-style-type: none"> 1. Reset the thermostat temperature 2. Check the operation of the sensor and replace if necessary 3. Check the panel and replace if necessary
The thermostove starts up "alone"	<ol style="list-style-type: none"> 1. Incorrect programming of the cronothermostat 	<ol style="list-style-type: none"> 1. Check the settings of the cronothermostat
The power does not change even if you manually adjust	<ol style="list-style-type: none"> 1. The board is set to automatic correction of power in proportion to the temperature 	<ol style="list-style-type: none"> 1. Contact your Authorized Assistance Center

Anomalies related to the plumbing circuit

PROBLEM	POSSIBLE CAUSE	REMEDY
No increase in temperature with stove in operation	<ol style="list-style-type: none"> 1. Incorrect combustion adjustment 2. Boiler/system dirty 3. Insufficient stove power 	<ol style="list-style-type: none"> 1. Check parameters 2. Check and clear the boiler 3. Check that the stove is properly sized for the requirements of the system

PROBLEM	POSSIBLE CAUSE	REMEDY
Condensation in boiler	<ol style="list-style-type: none"> 1. Incorrect setting maximum water temperature in the boiler 2. Insufficient fuel consumption 	<ol style="list-style-type: none"> 1. Set the stove to a higher temperature. The maximum water temperature in the boiler is 65 ° C and can not be set below 40 ° C or above 80 ° C. It is advisable to never adjust the temperature below 50/55 ° C to avoid condensation in the boiler. Adjust the power of the pump at a higher temperature to 50/55 ° C. 2. Contact your Authorized Assistance Center
Radiators cold in winter but the thermostove boils	<ol style="list-style-type: none"> 1. Circulator does not run because blocked 2. Radiators have air in them 	<ol style="list-style-type: none"> 1. Free up the circulator by removing the plug and turning the shaft with a screwdriver. Check the electrical connections of the same, replace if necessary 2. Vent the radiators
Hot water in not provided	<ol style="list-style-type: none"> 1. Circulator pump blocked 	<ol style="list-style-type: none"> 1. Free the circulator pump
The thermostove boils under “modulation” that reaches the temperature set on the thermostat of the thermostove	<ol style="list-style-type: none"> 1. It ‘been set to a value of thermostat too high 2. It was set too much power to the implant. 	<ol style="list-style-type: none"> 1. Lower the temperature in the boiler 2. Reduce the value of operating power
The thermostove goes into “modulation” as it reaches the temperature set on the thermostat of the thermostove even at low temperatures of the water in the boiler	<ol style="list-style-type: none"> 1. Modify the parameter for the maximum smoke temperature modulation to edit 2. Dirty stove: the fumes are too high temperature. 	<ol style="list-style-type: none"> 1. Contact your Authorized Assistance Center 2. Clean the tube bundle
High variability of domestic hot water temperature	<ol style="list-style-type: none"> 1. Water flow is too high 	<ol style="list-style-type: none"> 1. Reduce the flow of water (4/6 liters per minute)
Exits little hot water	<ol style="list-style-type: none"> 1. Insufficient water pressure in the network 2. Tap or mixer clogged with limescale 3. Water group clogged 4. The heat exchanger does not work 5. Air in: pump cavitation for the presence of air, the water does not rotate. 	<ol style="list-style-type: none"> 1. Check the setting of the pressure reducing valve 2. Install a water demineralizer 3. Check and clean the sanitary kit 4. Replace the plate heat exchanger 5. Bleed the brake system, remove air by venting the radiators.



Never turn off the heater by removing electricity.

Let always complete the shutdown cycle, otherwise you may damage the structure and have trouble lighting in the future.

Installation:

Your stove should be installed by correctly qualified and experienced personnel only. As with any heating appliance, incorrect installation can be extremely dangerous and may lead to personal injury or even death. We recommend that your installer is fully qualified and appropriately experienced in the installation of stoves and plumbing if appropriate (boilers and boiler stoves).

Stove Warranty

Your stove warranty is valid for two years (one year on electrical components) provided it is installed, commissioned and maintained as recommended by the manufacturer. It is very important to understand that any and all warranty claims may be rejected should your stove not be commissioned by one of our Authorised Technicians. See below for further details.

Your first point of contact for warranty issues is your Authorised Kalor Dealer (where you purchased your stove). They can assist you with any issue that you may have. They can

PLEASE NOTE:

Commissioning of your stove **MUST** be carried out by an Authorised Kalor Technician.

Signed Commissioning Sheet must be returned to us, within 30 days of stove installation to validate your stove warranty. Please return completed forms to:

Email: accounts@woodpelletstoves.ie

Post: Wood Pellet Stoves.ie, Shandrum, Newport Co. Mayo

If stove is not commissioned by an Authorised Kalor Technician, warranty is immediately voided.

Wood Pellet Stoves.ie

Newport, Co. Mayo, Ireland

Tel: 086 012 7744 **Email:** info@woodpelletstoves.ie

Web: www.woodpelletstoves.ie



woodpelletstoves.**ie**