

## Dear Customer,

We thank you for having chosen one of our products, the fruit of technological experience and of continual research for a superior quality product in terms of safety, dependability, and service.

In this manual you will find all the information and useful suggestions to use your product with the maximum safety and efficiency.



**Please remember that the first power must be carried out by our Authorized Assistance Center (Law 37/2008), which verifies the installation and completes the warranty. Any kind of tampering or unauthorized substitution with non-original spare parts can be dangerous to the safety of the operator and relieves the manufacturer from any civil or criminal liability.**

- Incorrect installation, incorrectly performed maintenance, improper use of the product release the manufacturer from every eventual damage derived from the use of the stove.
- The unit cannot be used as an incinerator. Do not use fuels other than pellets.
- This manual has been realized by the manufacturer and constitutes an integral part of the product and must remain with it during its entire lifetime. If the product is sold or transferred, be sure that the booklet is present since the information contained in it are addressed to the buyer, and to all those persons of various titles who complete the installation, use and maintenance.
- Carefully read the instructions and the technical information contained in this manual, before proceeding with the installation, use, and any operation on the product.
- The observance of the indications contained in the present manual guarantees the safety of people and the product, the economy of use and a longer functioning lifetime.
- Although the carefully studied design and the risk analysis done by our company has permitted the realization of a safe product, in any case, before effecting any operation on the stove, it is recommended to keep said manual available and pay scrupulous attention to the instructions written therein.
- Be very careful when moving the ceramic details where present.
- Check the precise flatness of the pavement where the product will be installed
- The wall where the product will be placed must not be constructed in wood, or in any case, made of an inflammable material, and in addition it is necessary to maintain a safety distance.
- While the stove is in operation, several parts of the stove (door, handle, sides) can reach high temperatures. Therefore pay attention and use the proper precautions, above all in the presence of children, elderly or disabled persons, and animals.
- Assembly must be performed by authorized persons (Authorized Assistance Center).
- Diagrams and drawings are furnished for the purpose of illustration; the manufacturer, with the intent of pursuing a policy of constant development and renewal of the product can, without any notice, make any modifications that are believed opportune.
- When the stove is working at its maximum speed, it is strongly suggested to wear gloves while handling with the door for pellets loading and the door handle.
- It is prohibited to install in bedrooms or in explosive environments.
- Only use replacement parts recommended by the supplier.



**Never cover the body of the stove in any way or obstruct the openings placed on the upper side when the device is operating. All our stoves are trial lighted on the construction line.**

**In the event of a fire, disconnect the power supply, use an extinguisher and call the fire fighters if necessary. After that contact the Authorized Assistance Center.**

This instruction booklet is an integral part of the product: make sure that it always accompanies the appliance, even in case of transfer to another owner or in the case of transfer to another place. In the event of damage or loss, request a copy from the area technician.

**These symbols indicate specific messages in this booklet:**



**ATTENTION:**

This warning sign indicates that the message to which it refers should be carefully read and understood, **because failure to comply with what these notices say can cause serious damage to the stove and put the user's safety at risk.**



**INFORMATION:**

This symbol is used to highlight information which is important for proper stove operation. Failure to comply with these provision will compromise use of the stove and its operation will not be satisfactory.

## Norms and declarations of conformity

Our company declares that the stove conforms to the following norms for the EC European Directive labelling:

- 2004 /108 CE (regulation EMC) and following amendments;
- 2006/95 CE (low tension regulation) and following amendments;
- 2011/65 EU (RoHS 2 directive);
- 2006/42 EC (machinery directive);
- The New Rules of Construction Products (CPR-Construction Products Regulation) No. 305/2011 regarding the construction world;
- For installations in Italy, please refer to UNI 10683/98 or following changes. For the water-thermo-sanitary equipment, let the installer give you the conformity declaration in compliance with L. 37/2008. While installing the unit respect the local, national and European rules;
- EN 55014-1; EN 55014-2; EN 61000-3-2; EN 61000-3-3; EN 60335-1; EN 60335-2-102; EN 62233, EN 50581.

### Safety information

Please carefully read this use and maintenance manual before installing and operating the stove!

If clarification is needed, please contact the dealer or the Authorized Assistance Center.

- The pellet stove must only be operated in living environments. This stove, being controlled by an electronic board, permits a completely automatic and controlled combustion; the exchange, in fact, regulates the lighting phase, 5 power levels and the shut down stage, guaranteeing the safe operation of the stove.
- The basket used for combustion allows most of the ash produced by the combustion of the pellets to fall into the collection compartment. Nevertheless, check the basket daily, given that not all pellets have high quality standards (use only quality pellets recommended by the manufacturer).

### Responsibility

With the delivery of the present manual, we decline all responsibility, both civil and penal, for accidents deriving from the partial or total lack of observance of the instructions contained herein.

We decline every responsibility derived from improper use of the stove, from incorrect use by the user, from unauthorized modifications and/or repairs, from the use of replacement parts that are not original for this model.

The manufacturer declines every civil or penal, direct or indirect responsibility due to:

- Lack of maintenance;
- Failure to observe the instructions contained in the manual;
- Use in non-conformity with the safety directives;

- Installation in non-conformity with the norms in force in the country;
- Installation by unqualified or untrained personnel;
- Modifications and repairs not authorized by the manufacturer;
- Use of non-original replacement parts;
- Exceptional events.



- **Use only wood pellets;**
- **Keep / store the pellets in a cool dry place;**
- **Never pour pellets directly on the hearth;**
- **The thermostove must only be fed with quality 6mm diameter pellets of the type recommended by the manufacturer;**
- **Before making the electrical connection of the thermostove the discharge tubes must be connected with the flue;**
- **The protective grill placed inside the pellet container must never be removed;**
- **The environment where the stove is installed must have a sufficient exchange of air;**
- **It is forbidden to operate the thermostove with the door open or the glass broken;**
- **Do not use the thermostove as an incinerator; the thermostove should be used only for the intended purpose;**
- **Any other use is considered improper and therefore dangerous. Do not put in the hopper other than wood pellets;**
- **When the thermostove is operating, the surfaces, glass, handle and tubes become very hot: during operation do not touch these parts without adequate protection;**
- **Keep the fuel and other inflammable materials off the thermostove.**

Fuel is loaded from the upper part of the stove by opening a door. Pour the pellets in the hopper. When empty, it will hold slightly more than a 45 kg sack.

This is easier if performed in two steps:

Pour half of the contents of the bag into the hopper and wait for the fuel to settle on the bottom.

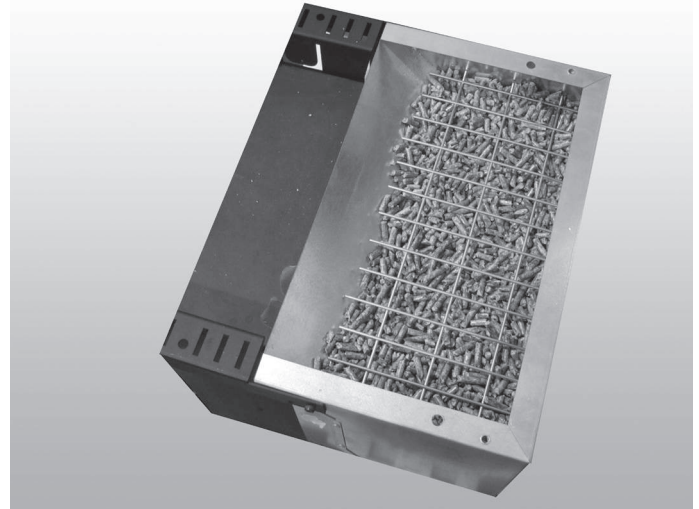
- Then pour in the second half;
- Keep the cover closed , after loading the pellets , the lid of the fuel tank;

The thermostove is a product by heating, presents the external surfaces particularly hot. For this reason, we recommend extreme caution when operating in particular:

- Do not touch the stove body and the various components, do not approach the door , it could cause burns;
- Do not touch the exhaust fumes;
- Do not perform any type of cleaning;
- Do not dump the ashes;
- Do not open the ash tray;
- Be careful that children do not come near;



**Never remove the protection grille in the hopper. When filling, do not let the sack of pellets touch any hot surfaces.**



## Instructions for safe and efficient use

- The appliance is not intended for use by persons ( including children) with reduced physical, sensory or mental capacities , or lack of experience or knowledge, unless they have been given through the intermediary of a person responsible for their safety, supervision or instruction concerning use of the appliance;
- Do not use the thermostove as a ladder or scaffold;
- Do not put clothes to dry on the thermostove. Any clothes hangers and suchlike must be kept a suitable distance from the stove. - Risk of fire
- Carefully explain that the thermostove is made from material subjected to high temperatures for the elderly , the disabled, and in particular for all children, keeping them away from the thermostove during operation
- Do not touch the thermostove with wet hands: the thermostove has electrical components that could produce sparks if handled incorrectly.
- Never open the glass door of the pellet stove while the thermostove is in operation.
- The thermostove must be connected to an electrical system equipped with an earthing conductor in accordance with regulations 73/23 and 93/98 EEC;
- The system must be of adequate electrical power declared the thermostove;
- Do not wash the inside of the thermostove with water. The water could damage the electrical insulation, causing electric shock;
- Do not expose your body to hot air for a long time. Do not overheat the room you are in and where the thermostove is installed. This can damage the physical conditions and cause health problems;
- Do not expose to direct the flow of hot air plants or animals;
- The pellet thermostove is not a cooking element;
- External surfaces during operation can become very hot. Do not touch them except with the appropriate protection.

## Operating area

For proper functioning and a good temperature distribution, the stove should be positioned in a location where it is able to take in the air necessary for combustion of the pellet (about 40 m<sup>3</sup>/h must be available), as laid down in the standard governing the installation and in accordance with local national standards.

The volume of the room must not be less than 30 m<sup>3</sup>.

The air must come in through permanent openings made in walls (in proximity to the stove) which give onto the outside, with a minimum cross-section area of 100 cm<sup>2</sup>.

These openings must be made in such a way that it is not possible for them to be obstructed in any way. Alternatively, the air can be taken from rooms adjacent to the one which needs ventilating, as long as they are provided with an air intake from the outside, and are not used as bedrooms or bathrooms, and provided there is no fire risk such as there is for example in garages, woodsheds, and storerooms, with particular reference to what is laid down in current standards.

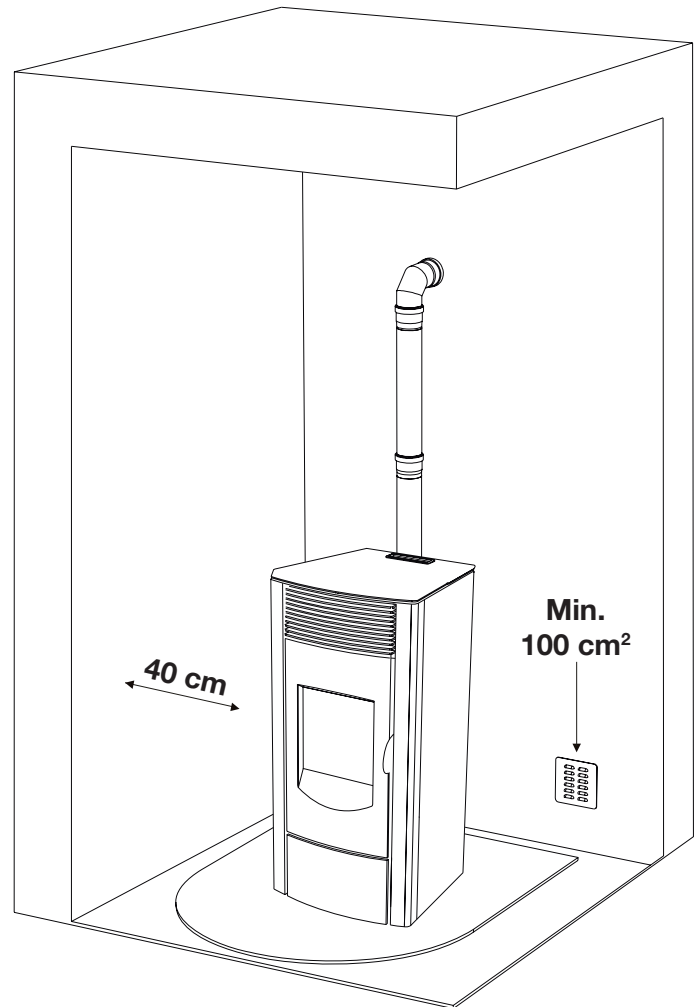


**It is not permissible to install the thermostove in bedrooms, bathrooms, or in a room where another heating appliance is installed (fireplace, stove etc.) which does not have its own independent air intake.**

**Locating the thermostove in a room with an explosive atmosphere is prohibited.**

**The floor of the room where the thermostove is to be installed must be strong enough to take its weight. If walls are flammable, maintain a minimum distance of 10 cm at the rear (A), of 40 cm at the side (B) and 150 cm at the front.**

**If the room contains objects which are believed to be particularly delicate, such as drapes, sofas and other furniture, their distance from the thermostove should be considerably increased.**



### Connection to the external air intake

It is essential that at least as much air must be able to flow into the room where the thermostove is installed as is required for proper combustion in the appliance and for the ventilation of the room.

This can be effected by means of permanent openings in the walls of the room to be ventilated, which give onto the outside, or by single or collective ventilation ducts.

For this purpose, on the external wall near the thermostove, a hole must be made with a minimum free cross-section of 100 cm<sup>2</sup>. (equivalent to a round hole of 12 cm diameter or a square hole 10x10 cm) protected by a grille on the inside and the outside.

The air intake must also: communicate directly with the room where the thermostove is installed be protected by a grille, metal mesh or suitable guard, as long as this does not reduce the area below the minimum.

Be positioned in such a way as to be impossible to obstruct.



**In the presence of wood floors, install a floor protection surface in compliance with the rules in force in the country**



**It is not compulsory to connect the air intake directly with the stove (so that it draws air directly from outside), but it is essential at all events to ensure an airflow of 50 cubic metres per hour by the use of a hole of the dimensions given. See standard UNI 10683.**

### Connection to the flue pipe

The flue pipe must have internal dimensions not larger than 20x20 cm, or diameter 20 cm. In the event of larger dimensions, or of the flue pipe being in poor condition (for example cracks, poor insulation, etc.), it is advisable to fit a stainless steel pipe of suitable diameter inside the flue pipe throughout its length, right up to the top.

Check with suitable instruments that there is a draught between 6 Pa and 10 Pa. This type of connection ensures the evacuation of the fumes even in the event of a temporary power cut.

At the bottom of the flue pipe, provide an inspection cap to allow periodic checking and cleaning, which must be done annually. Make a gas-tight connection to the flue pipe, using pipes and connectors as recommended by us. You must ensure that a windproof cowl should be fitted which complies with the standards in force

### Connection to an external flue with insulated or double-wall pipe

The only type of pipe which is permissible is insulated (double-walled) stainless steel, smooth on the inside, fixed to the wall. Flexible stainless steel pipe must not be used. At the bottom of the flue pipe, provide an inspection cap to allow periodic checking and cleaning, which must be done annually. Make a gas-tight connection to the flue pipe, using pipes and connectors as recommended by us. You must ensure that a windproof cowl should be fitted which complies with the standards in force.

Check with suitable instruments that there is a draught between 6 Pa and 10 Pa.

### Connection to the flue pipe

For proper functioning, the connecting pipe between the stove and the chimney or flue duct must have a slope of not less than 3% in the horizontal stretches, the length of which must not exceed 2 metres and the vertical distance between one tee connector and another (change of direction) must not be less than 1,5 m.

Check with suitable instruments that there is a draught between 6 Pa and 10 Pa. At the bottom of the flue pipe, provide an inspection cap to allow periodic checking and cleaning, which must be done annually.

Make a gas-tight connection to the flue pipe, using pipes and connectors as recommended by us. You must ensure that a windproof cowl should be fitted which complies with the standards in force.

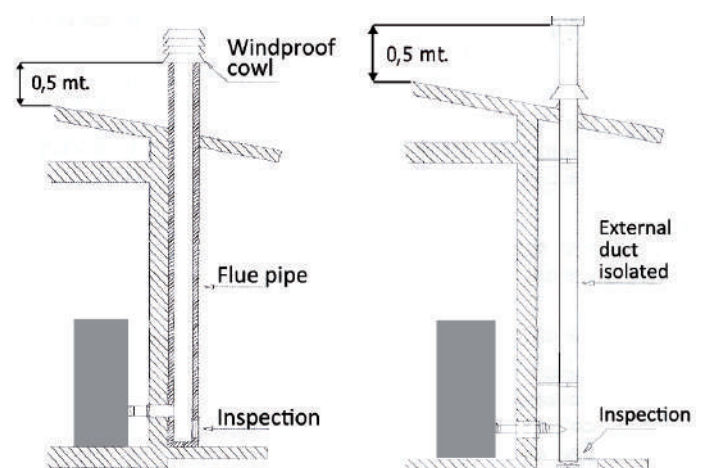
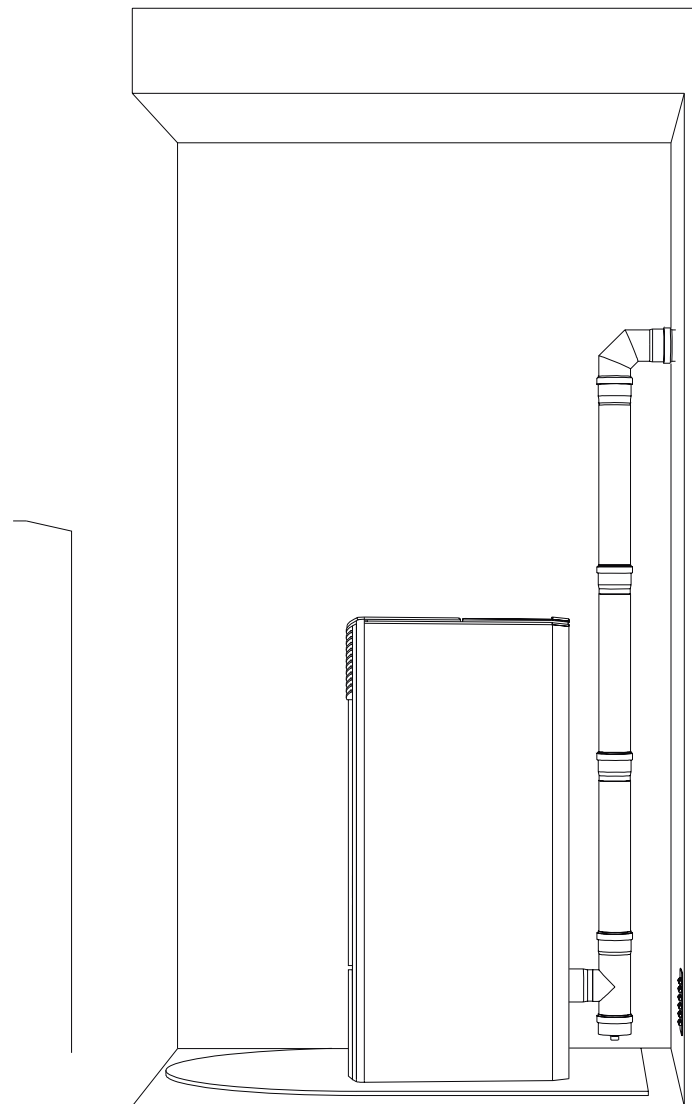


Fig. 2: connection to the flue pipe.

Fig. 3: connection to an external flue with insulated or double-wall pipe.



## Fireplace flue gas

Avoid contact with combustible materials (example: wooden beams) and in any case provide for their insulation with flame retardant material. In case of pipe penetrations through roofs or walls is recommended to use special kits crossing, certificates, are available commercially. In the event of a chimney fire, turn off the stove, disconnect from the network and never open the door. Then call the authorities.

## The chimney cap

The chimney cap must respect the following requirements:

- It must have the equivalent diameter and internal form of the flue.
- It must have a useful outlet diameter of not less than double that of the flue.
- The chimney cap on the roof or that remains in contact with the outside (for example, in case of open lofts or attics), must be covered with elements in brick or tile and must, in any case, be well insulated.
- It must be constructed to prevent rain, snow, and extraneous bodies from entering the flue and so that the discharge of the products of combustion is not inhibited by wind from any quarter or strength (wind-proof chimney cap).
- The chimney cap must be positioned in such a way as to guarantee the adequate dispersion and dilution of the products of combustion and in any case, must be out of the reflux zone. This zone has different dimensions and forms according to the angle of inclination of the roof so it is necessary to adopt minimum heights (Fig. 2).
- The chimney cap must be a wind-proof type and must be above the ridge.
- Eventual structures or other obstacles that are higher than the chimney cap must not be too close to the chimney cap itself.

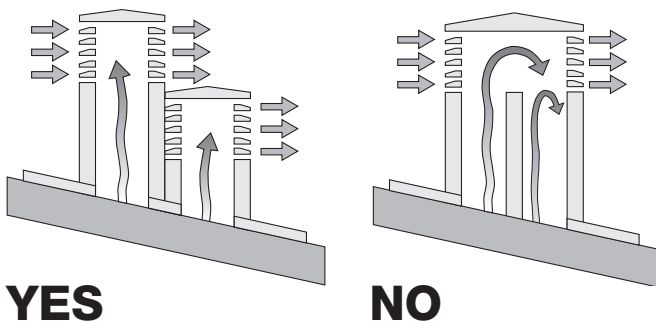
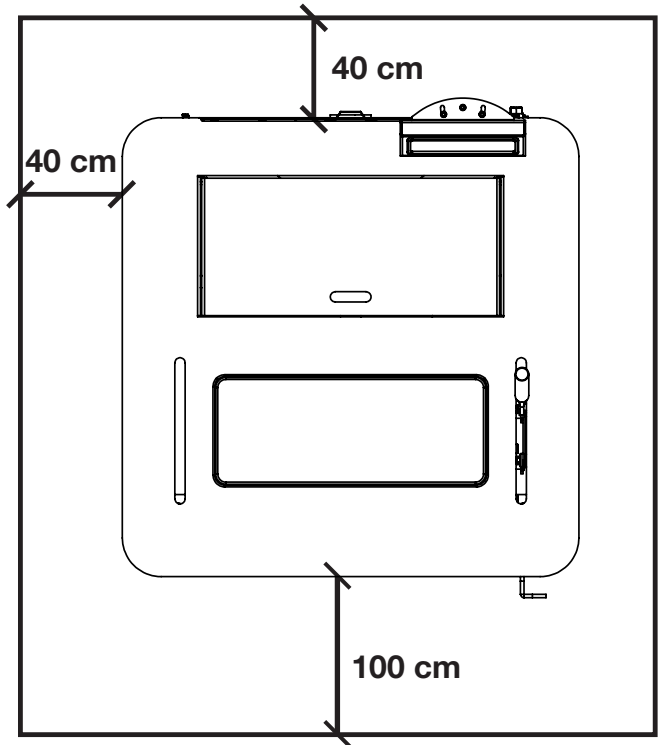


Fig. 5: Characteristics of chimney

## Distance to objects

The thermostove should be inspected on all sides, so you have to keep a distance of at least 40 cm at the back and sides. It is also recommended to keep the pellets and all flammable materials at a suitable distance



## REMARKS:

- the appliance must be installed by a qualified technician in possession of the technical and professional requirements according to the DM37/2008 that, under its responsibility, to ensure compliance with the rules of good technique.
- the thermostove must be connected to a heating system and/or to a network of production of sanitary hot water, consistent with its performance and its power
- you need to keep in mind all laws and national, regional, provincial and municipal laws of the country in which you installed the device
- check that the floor is not flammable: if necessary use a suitable platform
- in the room where the generator must be installed to heat must not pre-exist or be installed with an extractor hood or ventilation ducts of the collective type. Should these devices be located in adjacent rooms communicating with the installation, and 'prohibited the simultaneous use of the heat generator, where there is a risk that one of the two rooms being placed in depression than the other
- it is not permissible to install in bedrooms or bathrooms
- for hydraulic connections (see next chapter) it is advisable to use where possible of hoses

# Remote Control

The remote control (Fig. 3) used to adjust water temperature power and the on/off functions for the pellet thermostove.

To start the thermostove, press keys and simultaneously. The thermostove will automatically enter the starting phase.

Press keys and to adjust water temperature, and use keys e to adjust operating power.

To turn off the thermostove, hold down keys and simultaneously.

To replace the 12 volt battery located on the back of the remote control; use a screwdrives as a lever to lift the cover.

Replace the battery observing the correct polarity (Fig. 4)

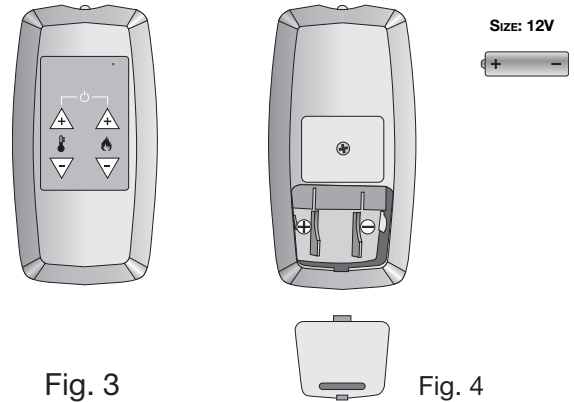
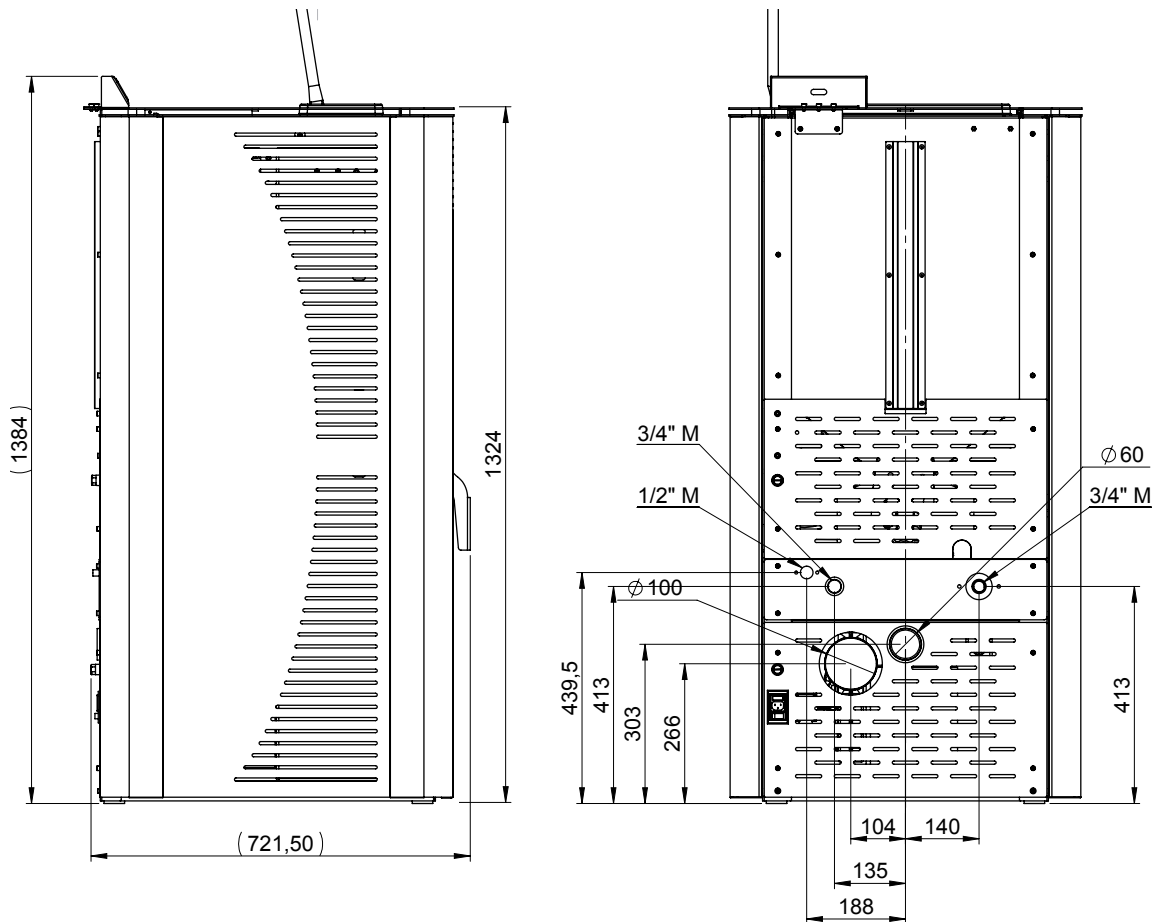


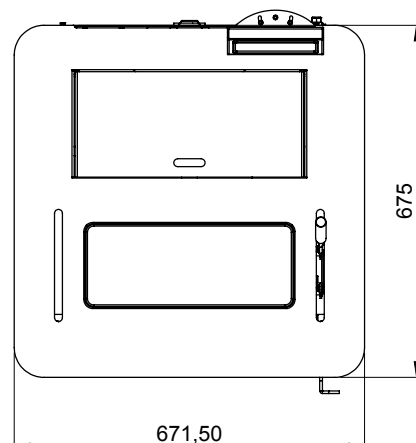
Fig. 3

Fig. 4

# Technical Specification




N.B.: measures with a tolerance of about 10 mm



PARAMETER	M. UNITS	NSAT280	NSAT320
Heat input	kW	27,34	32,41
Nominal heat output	kW	25,86	30,48
Reduced heat output	kW	8,57	8,57
Water heat output	kW	20,35	24,38
Reduced water heat output	kW	6,51	6,51
CO concentration at nominal reference (13% O <sub>2</sub> )	mg/m <sup>3</sup>	19,1	18,4
CO concentration at reduced reference (13% O <sub>2</sub> )	mg/m <sup>3</sup>	330,9	330,9
Nominal efficiency	%	94,56	94,03
Reduced efficiency	%	95,79	95,79
Pellet consumption (min-max)	Kg/h	1,825 - 5,575	1,825 - 6,608
Heated surface	mc	515	600
Flue gas flow rate (min-max)	g/s	7,9 - 15,1	7,9 - 18,6
Draft (min-max)	Pa	6 - 10	6 - 10
Flue gas temperature (min-max)	°C	77,7 - 113,9	77,7 - 125,2
Boiler water	litri	60	60
DHW flow rate	litres/minute	11,5	13,8
Maximum working pressure	Bar	2,5	2,5
Tank capacity	Kg	57	57
Smoke outlet tube	mm	100	100
Diameter air intake	mm	60	60
Connecting heating	Inch	3/4	3/4
Connecting health	Inch	1/2	1/2
Nominal voltage	V	230	230
Nominal frequency	Hz	50	50
Power consumption max	W	400	400
Thermostove weight	Kg	280	280
N° Test Report		K 11962013T1	




# Thermostove start up

 **Remove any components wich might burn from the firebox and from the glass (various instructions and adhesive labels)**

## Charge pellet


Fuel is loaded from the upper part of the thermostove by opening a door. Pour the pellets in the hopper. When empty, it will hold slightly more than a 45 kg sack. This is easier if performed in two steps:



- Pour half of the contents of the bag into the hopper and wait for the fuel to settle on the bottom.
- Then pour in the rest.



 **Never remove the protection grille in the hopper. When filling, do not let the sack of pellets touch any hot surfaces.**


 **The brazier should be cleaned before each starting.**

## Control Panel (Fig. 2)





Button  is used to switch on and / or off the thermostove and to exit programming.

Buttons  and  are used to adjust temperature, for displays and for the programming functions.

Buttons  and  are used to adjust heating power.

Button  is used to adjust temperature and programming functions.

The upper and lower displays are used to view different messages.

LED	SYMBOL	DESCRIPTION
①		The LED is on when the parameter UT01 on the menu is not on OFF and the weekly or daily programming are set.
②		The LED starts up every time the stove is loading pellets
③		The LED blinks when the board signalises a change in temperature or power set by the infrared remote control.
④		The LED is on when the room temperature reaches the value set on the menu SET Water.
⑤	"SET"	The LED blinks to indicate that you are entering the menu user/technician or that you are modifying the temperature set.
⑥		The LED switches on when the water circulator is working.

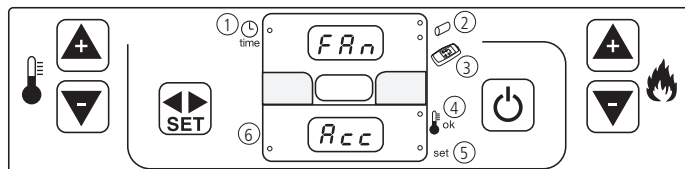




Fig. 2

 **It is advisable to use dry wood pellets, up to 6 mm in diameter.**

## Preliminary checks

Before switching on the pellet stove, make sure that the pellet hopper is full, the combustion chamber is clean, the glass door is closed, the power supply plug is connected and the switch on the back is set to "1."

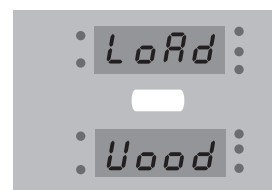
## Starting the thermostove

Press button  for a couple of seconds until the thermostove starts.

"FAN" will be displayed on the upper display and "ACC" on the lower one. During this phase the unit will carry out a diagnosis (around 20 seconds) on the fume extraction system.



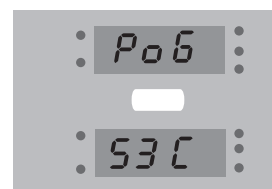
"LOAD WOOD", is the next phase, which indicates pellets should be fed. The glow plug will heat up to light the fire.



When the fume temperature is 50° C (approx. 10 minutes), the thermostove will confirm the ignition: "FIRE" will be shown on the upper display and "ON" on the lower one.



After this phase, which lasts around 5 minutes, the heating power (es. "PO6") and the room temperature (es. "25C"), will be simultaneously shown on the upper display, and the system delivery water temperature will be shown on the lower display.



If the flame does not start up correctly within 10 minutes, the thermostove jams: you will read the words "ALAR" on the upper display and the words "NO ACC": blinking on the lower display.

Wait 10 minutes until the cooling phase is completed, open the door, empty the brazier and start a new light-up.

**REMARKS:**

In case of repeated ignition lock-outs, while pellets are fed regularly, there may be a problem caused by a failing electric glow plug. In this case, while you wait for a technician, the pellet boiler stove can be manually started by using solid fuel cubes (firelighters).

**Manual starting procedure:**

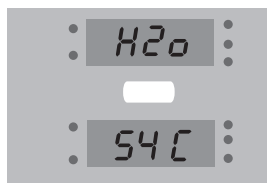
- open the door;
- take a solid fuel cube and place it inside the brazier together with some pellets;
- light a match and set fire to the solid fuel inside the brazier;
- wait a couple of minutes, close the door;
- follow the regular ignition procedure.



**Do not use any flammable liquid to start the stove. During the reload phase, do not bring the bag of pellets in contact with the hot thermostove.**

**Working power and water temperature settings**

The heating power is set by the keys and . A heating power at Po 9 is suggested during the first working hours of the stove.



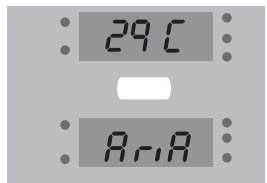
To set the water temperature press the key only once. You will see the words "SET H2O" blinking on the upper display. You will read the water temperature on the lower display.

Use the keys and to increase and reduce the wished value.

**Water temperature range: 30°C – 80 °C**

**Room temperature setting**

To set the room temperature, press the key twice: you will see the words "SET ARIA", blinking on the lower display. You will read the set temperature on the upper display.



Use the keys e to change the value.

**Room temperature range: 7°C – 40 °C**

**Fan speed setting for hot air**

It is possible to activate or deactivate the room ventilator placed on the front part of the stove.

The fan can be set with 5 different working speeds.

To set the fan for hot air, please join the following procedure: press the key twice to enter the setting menu for room temperature.

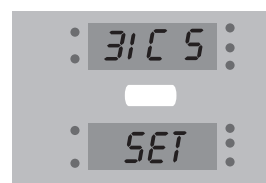
On the upper display, next to the room temperature, there

is a value which can go from 0 to 5. Pressing the key to increase power you can scroll the 5 available speeds. If you set the value "0", you will deactivate

On the following example, the fan for hot air is switched off. The speed is set on "0".



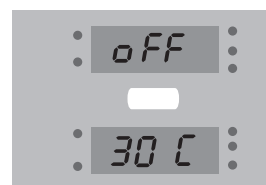
On the following example, the fan for hot air is working at its highest speed 5.



**This adjustment is only useful for turning on and off the hot-air delivery system because the temperature coming from the grates depends on the thermostove status.**

**Procedure to turn off the thermostove**

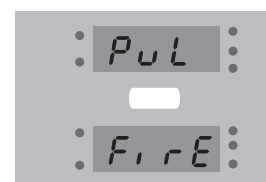
Turn off the pellet boiler stove by pressing button for a couple of seconds until "OFF" is shown on the upper display



Pellet feeding will stop immediately but the thermostove will continue working until the accumulated heat is fully consumed, turning itself off automatically **after a maximum of 30 minutes**.

**REMARKS:**

The thermostove is fitted with an automatic device that allows cleaning the brazier after a given period of time: when this time is detected, the stove fire automatically reduces and "PUL FIRE"; is shown on the display. After some minutes, the thermostove will start working regularly.



**Do not unplug the power plug to turn off the thermostove; wait until the automatic shutdown cycle finishes: the continuous operation of the fumes extraction fan is normal and may indicate that the stove is still hot. In the event of low temperatures, it might happen that the stove starts the smokes fan and circulator for some minutes in order to prevent ice formation on the pipes of the system. In the event there is a power drop, the main board will exhaust the smokes residuals as soon as the power supply is back on. In order to do that, the main board will increase the speed and show the words "COOL FIRE" on the display. As soon as the cooling phase has been completed, the stove will automatically start up working as it was set before the power drop.**

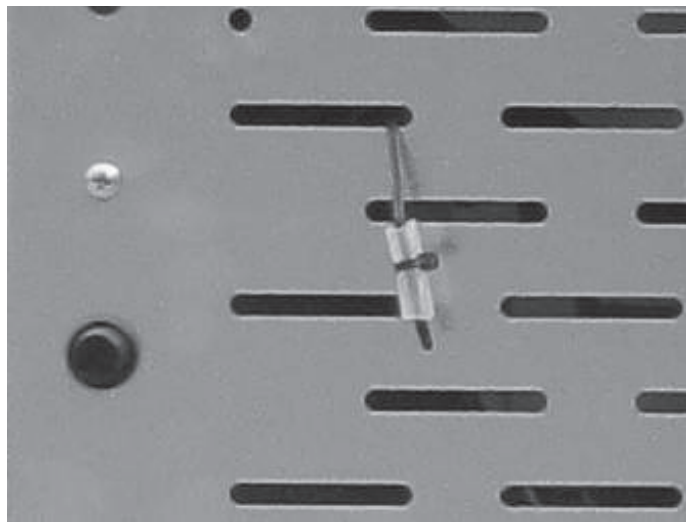
# Room sensor

## Internal room sensor

### Position of the probe internal environment

Only when the laying is finished recommended to check that the probe is lifted from its surroundings and away from the structure of the hot thermostove, to prevent it from detecting incorrect temperatures.

The room probe is located at the back of the thermostove. When using the internal thermostat, you should always set a slightly higher temperature a few degrees (eg 22 ° C, if you want to 20 °C environmental) because the probe is affected, however, the influence of the hot thermostove body.



## External room sensor

### Position of the probe external room sensor

The external thermostat is not included with the thermostove and is borne by the user.

The thermostove can also be controlled in temperature by a thermostat external environment. It is placed in a median position with respect to the local installation and ensure a better match between the heating temperature required and that actually provided by the same.

## Installation

Connect the two wires of the cable coming from the wall thermostat placed in the connector clamp. Insert the connector into the socket on the back of the thermostove.



Once you have connected the external thermostat the stove disables the internal thermostat.

The thermostove can work with the “stove modulation” (standard) or mode ECO-STOP.



The thermostove has set the standard ECO-STOP mode disabled.

## Example of operation:

If the room temperature detected by the sensor and highlighted on the control panel is 15° C and the set temperature is 20 ° C, the stove will follow a pre-established ramp up to the 5 th power and to the achievement of the target leads to the heater is minimum power. Once 20° C is reached, **it will go into standby mode et displays the word “ECO-STOP”**. When the room temperature drops below the value set on the control panel (for example 18° C) and a sufficient shut down time has elapsed, the thermostove will come back on automatically and continue running until again reaching 20° C.

Regardless of the operation of the external thermostat, the stove is equipped with an internal thermostat that works in the following way:

## Thermostove modulation turned on

The thermostove, when the set temperature is reached, will modulate its output to the minimum, that is, until there is again power demand. If despite the reduced power operation, in the modulation mode, the water temperature continues to rise to over 15° C of the set temperature and remains so for an interval of at least 60 minutes, the stove will turn off. Across the display will show **“STOP-FIRE”**. The subsequent automatic restart will occur as soon as the water temperature drops below 15° C above the set water temperature.


## ECO-STOP mode turned on

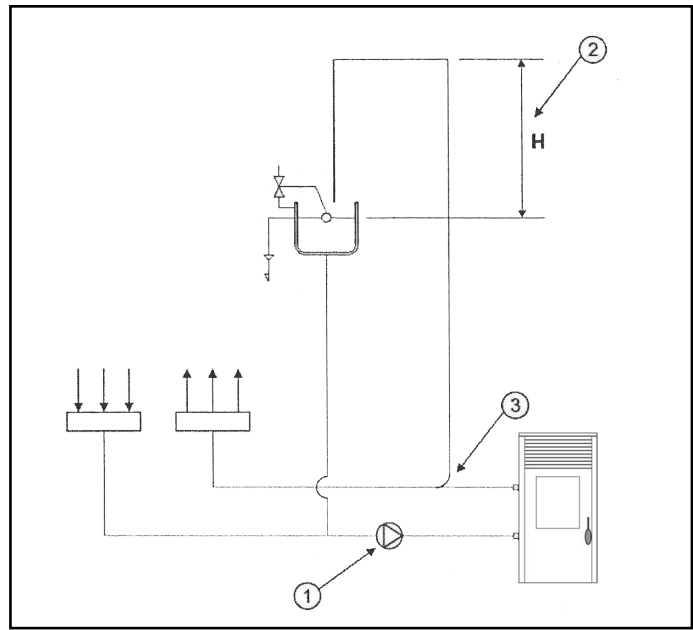
If you enable this functionality the thermostove, when the set temperature is reached, The thermostove will stabilize at minimum power for a time T1 which can be from a minimum of 1 minute, to a maximum of 30 minutes. If by this time there is a further request of temperature, the thermostove will automatically turn off and the display will show the message **“STOP-FIRE T ECO OFF”**.

The thermostove will automatically turn on only if there is a demand from the thermostat temperature. When the temperature drops below the value set on the thermostat (eg 18 ° C), the heater turns back on automatically until again reaching 20° C.

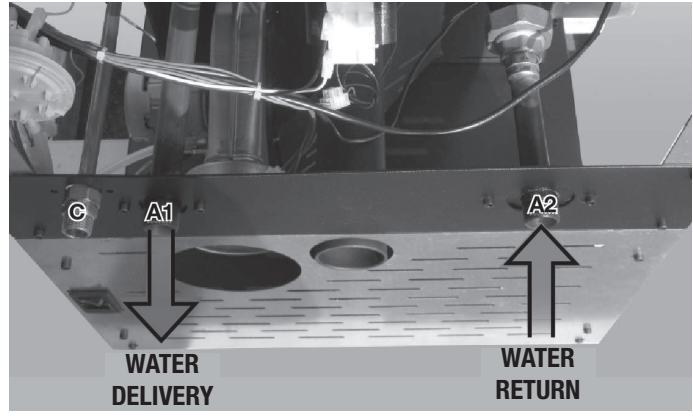


All the operations of automatic re-ignition, and in the case of lowering the ambient temperature of hot water demand, are possible if the heater is on or in ECO-STOP mode. If the user provides manually turned off using the power button, the stove does not perform automatic re-ignition upon temperature variation or if there is a demand for hot water. It is recommended that, in the presence of the kit for the production of domestic hot water, to disable the ECO-STOP mode to shorten the response time to the hot water demand.

 **The connection of the stove to the plumbing system must be made ONLY by specialized personnel who are capable of carrying out installation properly, in compliance with current standards in the country of installation. The manufacturer will not be held responsible for damage to persons or things in the event of failed operation if the aforementioned warning is not complied with.**

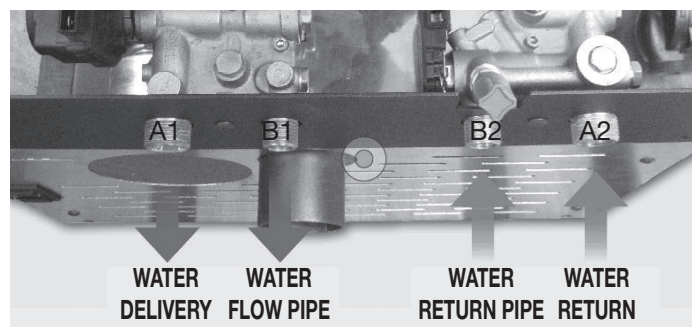


**Diagram connection kit without hot water thermostove**



The pressure relief valve (C) must always be connected to a water drain pipe. The tube must be capable of withstanding high temperature and pressure.

**Connection diagram for thermostove equipped with kit for domestic hot water production**



- A1 = heating water delivery 3/4 " M
- A2 = heating water return 3/4 " M
- B1 = domestic water flow pipe 1/2 " M
- B2 = domestic water return pipe 1/2 " M
- C = safety valve 3/4 " M
- D= reintegration 3/8 " M
- E= system emptying 3/4 " M

There are 2 different types of systems:  
 - Closed vessel system  
 - Open vessel system.

**Closed vessel system**

This product has been designed and built to work with closed vessel systems. In general, the closed vessel system has the following expansion as the expansion vessel pre-loaded. In addition to the expansion device, the closed vessel system must be provided in accordance with current Italian UNI 10412-2 (2009) by:

- safety valve
- thermostat control of the circulator
- device alarm sounds
- temperature Indicator
- pressure indicator
- audio alarm
- automatic adjustment
- safety thermostat with manual reset
- circulation system

**Open vessel system**

The open vessel system is a more secure system that does not require the addition of further securities. The fireplace stoves, wood boilers and stoves necessarily require use of an open vessel system. A plant run open vessel, connected to a thermoproduct, may provide for circulator mounted on the return, in this way the system would work at lower temperatures to the advantage of a longer life. While working under optimal conditions, the pump mounted on the back can push the water through the tube pan on safety and can make it back in the system through the inlet pipe causing a phenomenon of oxygen that is highly damaging to life of the boiler.

To prevent this phenomenon, it is possible to apply the following measures:

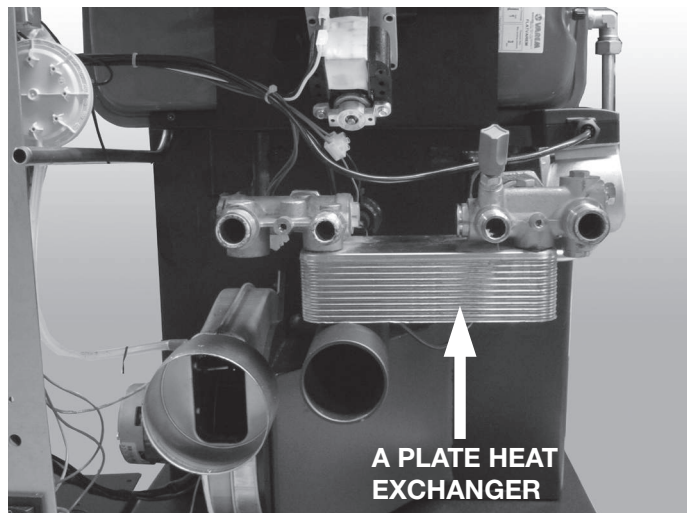
- lower the speed of the pump so as to reduce the prevalence
- hold, if possible, the tray a little lower and raise the maximum allowed the safety tube
- perform the separation between the safety pipe and the discharge pipe, not at an angle of 90 ° but with a curved connection.



The thermostove can also be equipped with a **full kit for the production of domestic hot water**.

This kit comprises:

- a plate heat exchanger
- a three-way diverter valve
- water flow switch
- pipes and unions for connection



The kit is preassembled by the manufacturer's task is to heat the domestic water from the water line of the dwelling. In the moment in which there is request for opening a hot water tap, the flow switch commands the diverter valve to convey the hot water contained inside of the thermostove towards the plate heat exchanger.

In the case in which the heater is turned off and there is demand for sanitary water, the heater after 30 seconds from the request, it automatically starts the ignition process to heat the water inside the boiler and then to heat the sanitary water.

#### Directions for use

If the installation of the thermostove provides interaction with another existing system complete with a heater (gas boiler, gas boiler, oil boiler, etc..) consult qualified personnel who can then answer the compliance of the system, as envisaged by the law in force.

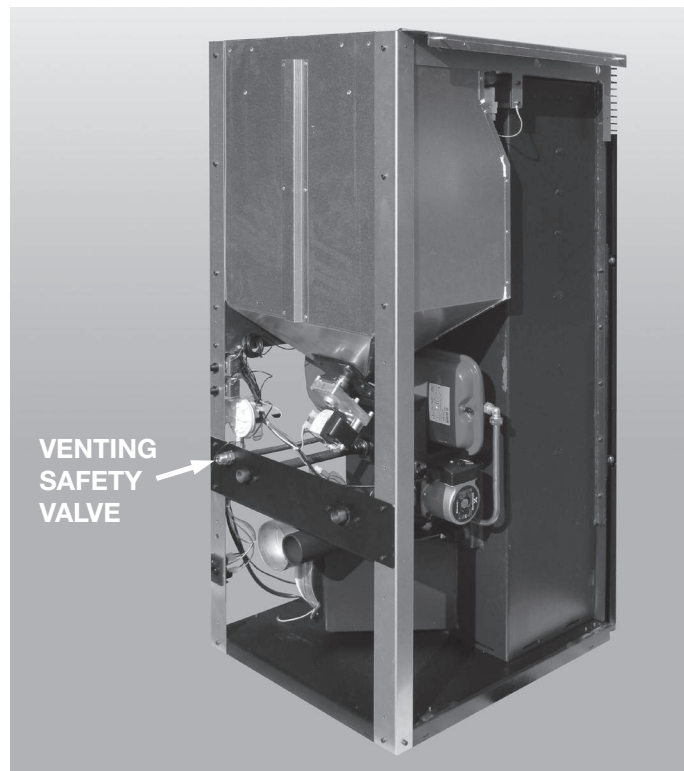
#### Flushing the system

**In accordance with the UNI-CTI 8065 is strongly recommended to wash the entire system before connecting it in order to get rid of residues and deposits.** After flushing the system to protect it against corrosion and deposits, it is recommended the use of inhibitors.

Upstream from the stove, always install shutters so as to disconnect it from the plumbing system should it be necessary to move it, or when it requires routine and/or special maintenance. Connect the stove using hoses so that the stove is not too strictly connected to the system, and to allow slight movement.

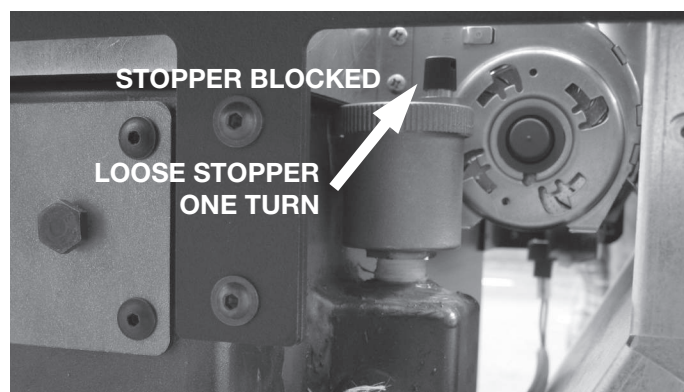
These are as helpful as the supply and return piping system if the heating system is on a higher floor than the boiler.

The exhaust pipe pressure is connected temporarily to a carafe or a funnel to avoid, in case of overpressure, that the water gush bathrooms and the structure and the floor.



#### Filling the thermostove funding of heat kit

Once all the water connections, proceed to check pressure seal by filling the thermostove. During this operation, any air in the system is released from the **automatic vent valve**.



The filling pressure of the system **when cold** must be **1 bar**.

During operation, if the system pressure drops (due to evaporation of dissolved gases in the water) to values lower than the minimum indicated above, the user must use the filling tap to bring the pressure back up to its normal pressure.

For proper operation of the stove **when hot**, the pressure in the boiler must be **1,5 bar**.

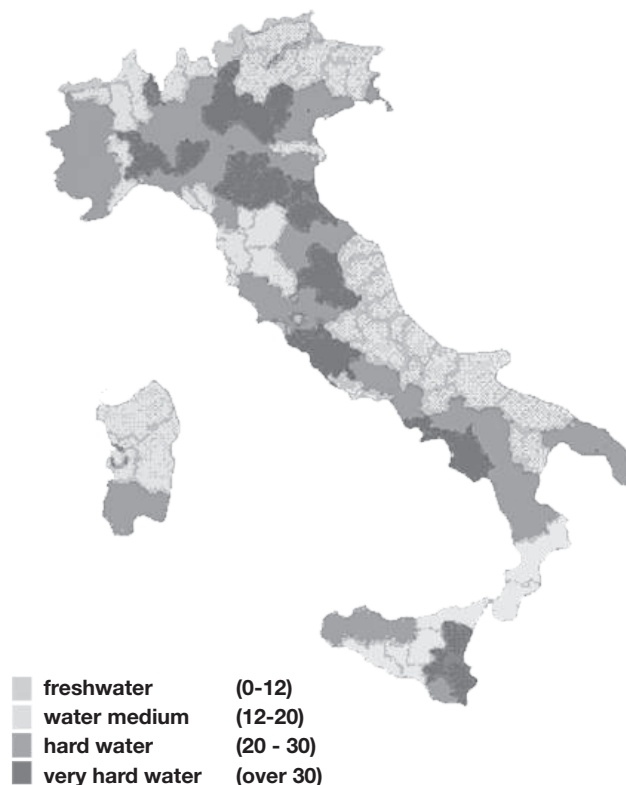
## Water Characteristics

The characteristics of the water used to fill the system are very important to prevent the build-up of mineral salts and the formation of incrustations along the pipes, in the boiler and in the heat exchangers.

Therefore, please get your plumber's advice concerning:

- Hardness of water circulating in the system, to prevent problems of incrustation and limescale, especially in the domestic water heat exchanger (>25° French).
- Installation of a water softener (if water hardness > 25° French).
- Filling the system with treated water (demineralised).

If you have very extensive system, with a large amount of water, or which require frequent refilling, it is recommended the installation of water softening system. It should be noted that the encrustations drastically reduce performance because of their low thermal conductivity.



## Heating timer-thermostat

The heating timer-thermostat function is used to program the pellet boiler stove to automatically turn on and off within a period of one week.

To access programming, hold down button  $\triangleleft \triangleright$  for around three seconds, "UT01" will be shown on the upper display: by pressing button  $\triangleleft \triangleright$  several times and referring to the table below, the stove can be programmed according to your needs. Press button  $\odot$  to exit the programming phase at any time.

These are the heating timer-thermostat parameters:

Parameter	Description	Programmable values
UT01	H. timer-thermostat enabling and disabling. Day of the week setting	OFF; Day 1, ..., Day7
UT02	Current hour setting	From 00 a 23
UT03	Current minutes setting	From 00 a 60
UT04	Technical parameters setting	Reserved
UT05	Thermostove first start-up time adjustment	From 00:00 to 23:50 with 10-minute steps
UT06	Thermostove first shutdown time adjustment	From 00:00 to 23:50 with 10-minute steps
UT07	Week day selection, first time activation	Between on/off for days from 1 to 7
UT08	Thermostove second start-up time adjustment	From 00:00 to 23:50 with 10-minute steps

Parameter	Description	Programmable values
UT09	Thermostove second shutdown time adjustment	From 00:00 to 23:50 with 10-minute steps
UT10	Week day selection, second time activation	Between on/off for days from 1 to 7
UT11	Thermostove third start-up time adjustment	From 00:00 to 23:50 with 10-minute step
UT12	Thermostove third shutdown time adjustment	From 00:00 to 23:50 with 10-minute step
UT13	Week day selection, third time activation	Between on/off for days from 1 to 7
UT14	Thermostove fourth start-up time adjustment	From 00:00 to 23:50 with 10-minute steps
UT15	Thermostove fourth shutdown time adjustment	From 00:00 to 23:50 with 10-minute steps
UT16	Week day selection, fourth time activation	Between on/off for days from 1 to 7



**UT01: Heating timer-thermostat enabling and disabling and current hour setting.**

This parameter is used to set the current day of the week or to deactivate the set programming.

Press buttons and to select the desired value as shown in the following table:

Upper display	MEANING
Day 1	Monday
Day 2	Tuesday
Day 3	Wednesday
Day 4	Thursday
Day 5	Friday
Day 6	Saturday
Day 7	Sunday
OFF	Heating timer-thermostat disabled

**Example:**

if today is Thursday, select “DAY 4”; but select “OFF” to start the pellet boiler stove manually (without programming) so that the heating timer-thermostat is disabled. Press button to go to the following parameter.

**UT02: Current hour setting**

This parameter is used to set the current hour, press buttons and to select the current hour. Press button to go to the following parameter.

**UT03: Current minutes setting**

Press buttons and to adjust current minutes. Press buttons to go to the following parameter.

**UT04: Technical parameters setting**

Press button to go to the following parameter.

**UT05: Thermostove first start-up time adjustment**

This parameter indicates the time at which the pellet boiler stove will be started: use buttons and to set the desired time, with 10-minute steps. Press button to go to the following parameter.

**UT06: Thermostove shutdown time adjustment**

This parameter indicates the time at which the pellet boiler stove will be turned off: use buttons and to set the desired time, with 10-minute steps. Press button to go to the following parameter.

**UT07: Week day selection**

Press button to select the days of the week. Press button to enable (ON) or disable (OFF) the pellet boiler stove start-up day as shown in the following table:

Upper display	MEANING	Lower display
Day 1	Monday	ON1/OFF1-Si o No
Day 2	Tuesday	ON2/OFF2-Si o No
Day 3	Wednesday	ON3/OFF3-Si o No
Day 4	Thursday	ON4/OFF4-Si o No
Day 5	Friday	ON5/OFF5-Si o No
Day 6	Saturday	ON6/OFF6-Si o No
Day 7	Sunday	ON7/OFF7-Si o No

In the following example, the pellet boiler stove is only started on Saturdays and Sundays.

Day 1 Monday	Day 2 Tuesday	Day 3 Wednesday	Day 4 Thursday	Day 5 Friday	Day 6 Saturday	Day 7 Sunday
off 1	off 2	off 3	off 4	off 5	on 6	on 7

Confirm and continue with key .

**UT08 → UT16**

continue as indicated above to set the second, third and fourth ignition times.

If the stove is controlled by an external thermostat, when the thermostat reaches the preset temperature, “ECO TERM” will be shown on the pellet boiler stove display.

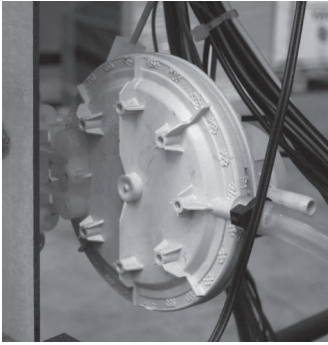
**The room temperature thermostat does not turn off and on the pellet boiler stove; it sets the stove in saving mode.**

**Domestic hot water kit (optional)**

Thanks to an optional kit, pellet boiler stoves can also produce continuous domestic hot water healthy, safely and automatically, without the need for water storing.

**Domestic water pressure should not exceed 2 bars. There is anyway an electronic control limiting the system pressure to a max. value of 2,3 bar.**

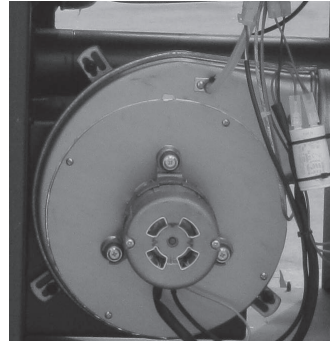
It is advisable to limit domestic water flow rate to approx. 8÷12 litres per minute in order to obtain a ΔT of approximately 25°C.



**Pressure switch:** monitors depression in the smoke duct. It is designed to shut down the pellet feed screw in the event of an obstructed flue or significant back-pressure in the presence of wind. At the time of the pressure switch will show **"ALAR-DEP-FAIL"**.



**Reduction motor:** if the motor stops, the thermostove continues to function until the flame goes out for lack of fuel, and until it has cooled down to the minimum level.



**Flue gas temperature sensor:** thermocouple that measures the temperature of the fumes while keeping the operation or shuts the thermostove when the flue gas temperature drops below the preset value.



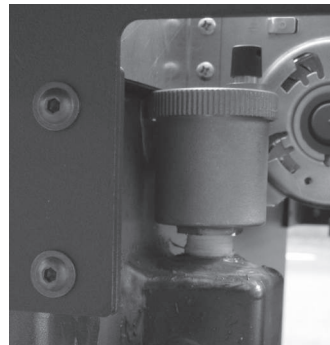
**Electrical safety:** the stove is protected against violent surges of current (ex. lightnings) by the main fuse 4 A which is located on the control panel at the rear of the thermostove. Other fuses to protect the electronic boards are to be found on the boards themselves.



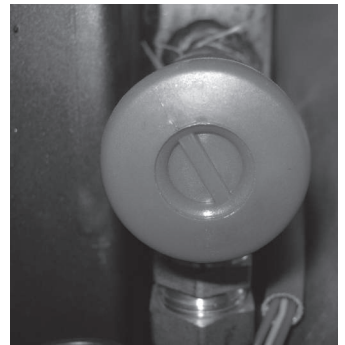
**Safety thermostat with manual reset for the water temperature:** if the temperature of the water tank exceeds the preset safety level of 100 °C immediately stops the operation of the thermostove and the display will show **"ALAR-SIC-FAIL"**. To restart you need to reset manually.



**Water temperature probe:** if the water temperature approaches the blocking temperature (100 °C), the probe requires to interrupt the supply of pellets.



**Automatic vent valve:** this valve eliminates the air inside the thermostove and of the heating system.



**Safety valve:** this valve acts to prevent over pressurization of the hydraulic system. If the pressure of the thermostove or plant exceeds 2.5 bar it drains the water from the circuit.

**Anti-freeze function:** if the probe in the thermostove detects a water temperature of less than 5°C, the circulation pump is automatically activated to keep the system from freezing.

**Pump anti-seizure function:** if the pump is not used for prolonged periods, it is activated periodically for 10 seconds, to prevent it blocks.



**Tampering with the safety devices is prohibited.** It is only after eliminating the cause which gave rise to the intervention of the safety system, that it is possible to relight the stove and thus reset the automatic operation of the sensor. To understand which anomaly has occurred, consult this manual at paragraph relating to alarms which explains what to do based on the alarm message the stove display.

# Alarm signals

In the event of a working defect, the system informs the user about the type of failure occurred. The following table summarises the alarms, kind of problem and possible solution:

Upper Display	Lower Display	Kind of failure	Solution
ALAR	NO ACC	The thermostove cannot start up This is the first light-up	Fill in the tank with pellets Start up again
ALAR	NO FIRE	The pellet boiler stove switched off while working	Fill in the tank with pellets
ALAR	SOND FUMI	The smokes sensor is broken or not connected to the pcb	Contact an Authorized Assistance Center
ALAR	HOT H2O	The water temperature exceeds 90°C. The circulating pump is blocked or there is no water in the hydraulic system	Check the power supply on the pump. Check limestone does not block the pump impeller
ALAR	SOND H2O	The water sensor is not connected There is a short circuit on the water sensor	Check the water sensor is connected Contact an Authorized Assistance Center
ALAR	HOT TEMP	The smokes temperature exceeds 280°C	Smokes sensor failure Contact an Authorized Assistance Center
COOL	FIRE	There is no power supply	As soon as the power supply is back, the stove starts a cooling cycle. After completing the cycle it starts working automatically
ALAR	FAN FAIL	Smokes extractor blocked or broken	Contact an Authorized Assistance Center
ALAR	DEP FAIL	Obstructed flue	Clean the flue or check there are no obstructed grids near the smokes exhaust
ALAR	SIC FAIL	Pellets tank overheating	Re-set the safety thermostat for pellets on the back of the stove. If the problem occurs again, contact an Authorized Assistance Center
ALAR	PRESS	The system pressure does not reach 0,5 bar or exceeds 2,3 bar	Reduce the system pressure Charge the system
SERV		The stove has worked for 1300 hours. Supplementary maintenance required	Contact an Authorized Assistance Center

**Regular checks should be carried out by the user, who should only contact the Authorized Assistance Center if no solution is found.**

## Failed light-up

If the flame does not light up during the switching on or if the smokes temperature does not reach a suitable value in the foreseen time gap, the thermostove switches off and you will read the words **"ALAR NO ACC"** on the display. Press the key "On/Off" to reset the alarm. Wait until the cooling phase is completed, clean the brazier and start a new light-up.

## Switching off while working

The thermostove suddenly switches off while working (for example because it has run out of pellets in the tank or because the motor reducer for pellets loading got broken). The thermostove continues working until the pellets left in the brazier ends. You will then read the words **"ALAR NO FIRE"** on the display and the stove switches off. Press the key "On/Off" to reset the alarm. Wait until the cooling phase is completed. Clean the brazier and start a new light-up.

**These alarms remind you that the brazier must be cleaned and installed correctly before switching on the thermostove.**

## There is no power supply

In the event of a power drop longer than one minute, the thermostove can exhaust some smoke in the room: this causes no risks.

As soon as you have the power supply again, the thermostove will have the words **"COOL FIRE"** on the display. After completing the cooling phase, the thermostove will start up again automatically according to the previous settings.



**Do not attempt to start the thermostove before the required time or it may get blocked. If this occurs, switch off the switch on the back of the pellet boiler stove for 1 minute, set it on again and wait 10 minutes before starting the thermostove again.**





**The power socket where the thermostove is connected should be fitted with "earth connection complying with regulations in force." The Manufacturer shall not be held responsible for damage to things or people resulting from negligent installation.**

## Manual restart thermostat



## System pressure safety

The system pressure is checked electronically and needs to be between 0,5 and 2,3 bar. If this is not the case, the pellet boiler stove signals an alarm and shows the words **"ALAR PRESS"** on the display.

Press the key  on the display. Check the system pressure keeping the key  pressed for some seconds. You will read the bar value on the display.

The safety valve keeps anyway the value under 2,5 bar letting the exceeding water flow out automatically.

## Intervention in case of danger

In case of fire, disconnect the power supply, use a fire extinguisher in accordance with, and if necessary, call the fire department and then contact an authorised qualified technical assistance

# Maintenance and cleaning



All cleaning of all parts must be carried out with the stove completely cold and unplugged to avoid burns and thermal shock. The stove does not need much maintenance if used with certified quality pellet. The need for maintenance varies depending on the conditions of use (switching on and off repeatedly) and depending on the performance required.

Parts	Everyday	Every 2-3 days	Every week	Every 15 days	Every 30 days	Every 60-90 days	Every 1 year
Brazier	◇						
Cleaning the ash collection compartment with suction device		◇					
Cleaning ash tray		◇					
Cleaning the door and glass		◇					
Exchanger (turbulators)	◇						
Cleaning the interior heat exchanger / smoke fan compartment						•	
Cleaning complete exchanger							•
Clean "T" to exhaust						•	
Flue							•
Door gasket ash						•	
Internal parts							•
Flue pipe							•
Circulation pump							•
Plate heat exchanger							•
Hydraulic components							•
Electromechanical components							•

◇ by the user



• by the authorised qualified technical assistance


## BY THE USER

### Daily control

The thermostove requires a simple and thorough cleaning in order to ensure a more efficient performance and smooth operation.

While cleaning the inside of the thermostove, to prevent the escape of ashes, you can start the fan flue exhaust.

To enable this feature, you must press the button  and then .

The display shows "PUL STUF" (cleaning thermostove). To stop the fan, simply press and hold the button  or wait for completion of a cleaning cycle (255 seconds).



Clean the grate using the appropriate tool from the ash and any incrustation which could obstruct the passage of air. In the case of depletion of pellets in the tank may accumulate unburned pellets in the burn pot.

Always empty the residuals from the grate before each start. Remember that only a brazier located and clean properly can ensure ignition and optimal operation of your thermostove. When positioning the crucible, carefully check that the ends of the pads completely adhere to their home and that the hole with pipe dedicated to the passage of the resistance.

There should be no residual combustion in the contact zone between the edges of the crucible and the support surface on the door crucible.

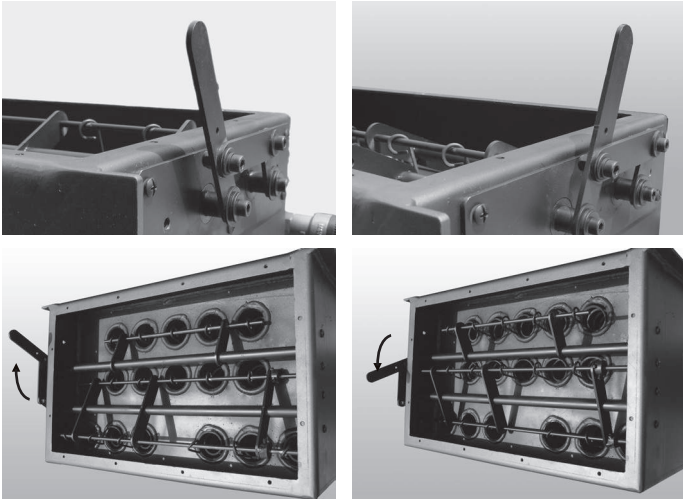


The decreased or absent cleaning can cause misfire and cause damage to the thermostove and the environment (possible emissions of soot and unburned). Do not pour the pellets may be present in the brazier to misfire.



### Cleaning exchanger - stove off

Fouling act as insulation and the thicker they are, the lower the heat that is transmitted to the water and to the structure generally. Therefore very important to perform the cleaning of the tube bundle, said exchanger also, to prevent the fouling of the same and prevent clogging and jamming of the cleaning device. Pull and push quickly for 5-6 times the lever so that the springs can remove the soot deposited on the pipes.



**Check every 2/3 days**

### Cleaning the ash collection compartment.

Clean and empty the ash tray being careful with hot ash. The ash must be completely cold for a vacuum cleaner to be used to remove it. Only if the ash is completely cold, you can also use a canister vacuum cleaner suitable for picking up particles of a certain size.

**Cleaning ash and combustion chamber** including the spark plug lead

### Cleaning the glass

For cleaning the ceramic glass, the use of a dry brush is recommended, or if it is very dirty, the special spray detergent, applying a small quantity then cleaning with a cloth.



**Do not use abrasive products and do not spray the cleaning product on the glass of the painted parts or on the gaskets of the fire door (ceramic fibre cord).**

### Cleaning of stainless steel and satin-finish surfaces

Normally these surfaces do not need to be treated, but if they do, avoid cleaning them with abrasive materials. For surfaces in stainless and satin brushed steel we recommend cleaning with a paper towel or a clean dry cloth moistened with a detergent based on non-ionic surfactants (<5%) A spray glass cleaner may be used.



**Avoid contact with skin cleanser and eyes. In case this happens, sprinkle with plenty of water and contact the nearest medical center.**

### Cleaning of painted parts

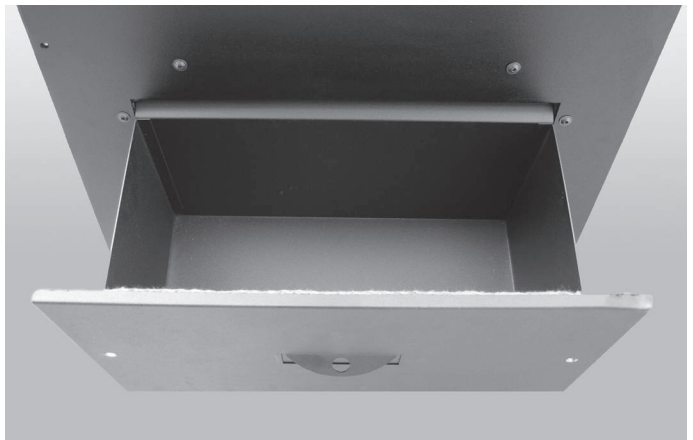
Do not clean the painted parts with wet rags when the unit is in operation or hot to prevent thermal shock to the paint which may cause it to detach. Do not use abrasive or aggressive products or materials. Clean with damp cotton or paper towels. The silicon paints used by manufacturer possess technical characteristics that make them resistant to very high temperatures. There is however a physical limit (380° - 400°) beyond which the paint begins to fade or (over 450°) to vitrify; it may then flake and detach from the steel surface. If this happens, it means that temperatures have been reached that are far above those at which the unit should operate properly.



**Do not use abrasive materials or harsh. Clean with damp cotton or paper towels.**

**Check every 7 days**

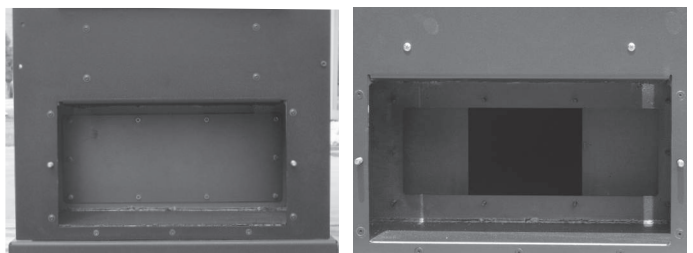
**Clean bottom ash** from the fallen debris during operation. You can access the ash pan by loosening the two wing nuts that hold the drawer inspection. Remove the tray, empty and clean the wall and only the corners with a suction device or with dedicated tooling. Then mount the drawer and tighten the two knobs being careful to restore the tightness, very important during operation.



**Check every 60/90 days**

### Cleaning the interior baffle / smoke fan compartment.

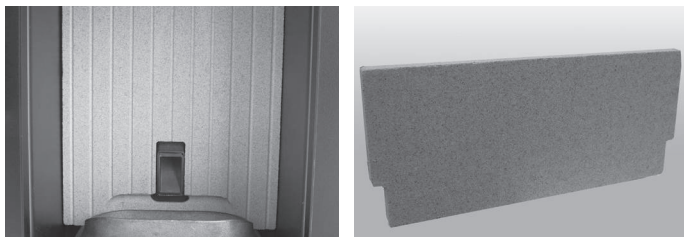
Inside the compartment where there is the ash tray, there is a second cover, fixed by the cockerels, which gives access to the compartment at the base of the duct dedicated to the flue and the wall of the fume extractor fan. Use a suction device for thorough cleaning of the cabinet. Check the integrity of the seal in ceramic fiber.





## Cleaning battifiamma

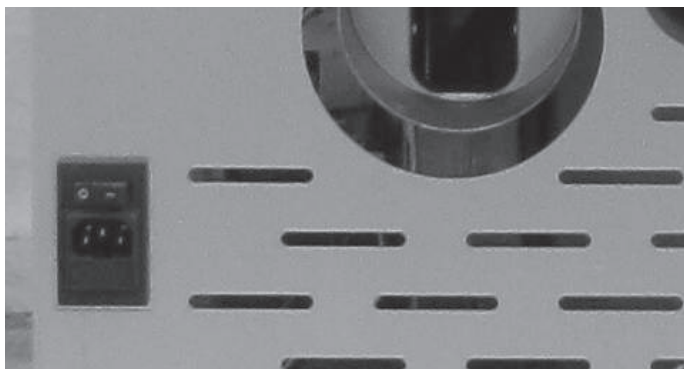
The thermostove is provided with two elements in vermiculite: the bottom of the combustion chamber and the battifiamma.



Vermiculite is a mineral from a variety of uses in industry and construction for its insulating properties, thermal and acoustic properties. In this case, the vermiculite is used to avoid unnecessary heat dispersions. Because of its fragility, it is recommended to handle with extreme care battifiamma during the cleaning of the combustion chamber and clean it only with a soft, dry cloth.

## Shutting the thermostove down

In the period when the thermostove is out of use it must be disconnected from the electricity mains. For greater safety, especially if there are children around, we recommend removing the power cable from the rear of the thermostove.



Before placing the thermostove in storage, you should remove all pellets from the hopper with a vacuum cleaner with a long extension. If the fuel is left in the hopper, it may get damp, stick together, and be difficult to light at the beginning of the next season.

If pressing the main switch (located on the back of the stove) does not make the control panel display light up, it could mean that the service fuse needs replacing.

On the rear of the stove there is a fuse holding compartment which is located underneath the supply socket. With a screwdriver open the cover of the fuse holding compartment, and replace the fuse if necessary (3,15 AT delayed type). Plug the unit back in and press the main switch.

## CLEANING BY THE TECHNICAL

### Check every year

#### Compartment ventilation flue gas cleaning

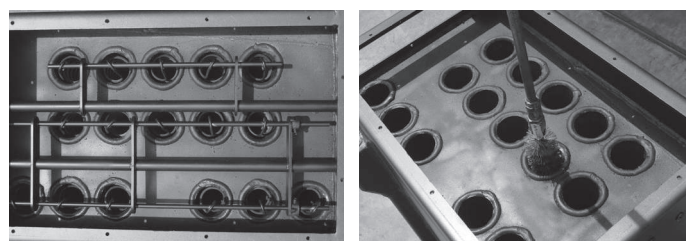
Remove the fixing screws and remove the smoke fan for cleaning of the same. Perform the task with the greatest care not to bend the fan blades.

#### Clean flue

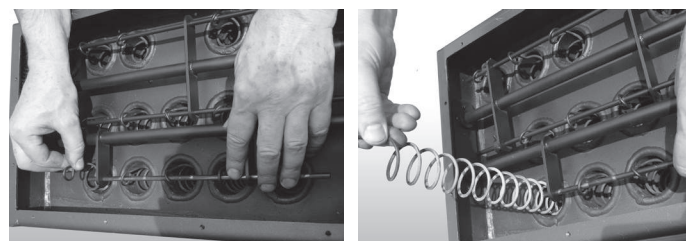
Clean the flue system especially near the fittings to "T", curves and any horizontal sections. Is necessary to check and remove any deposit of ash and soot before the same clogging the passage of smoke.

#### Cleaning the exchanger

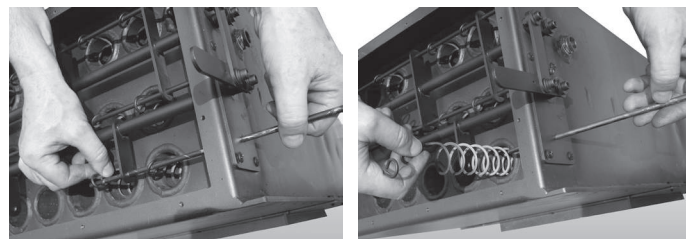
Lift the upper door that covers the tube by unscrewing the screws. Pull out the 16 soft brush and wipe with a clean 16 exchanger tubes.



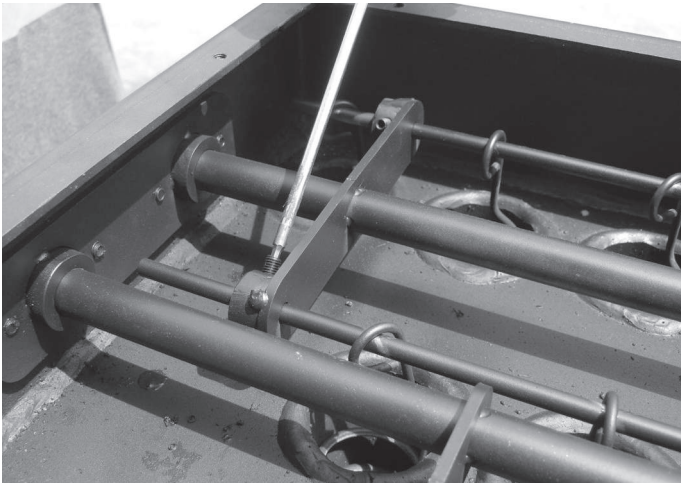
Perform cleaning after removing the springs inserted in each pipe. The operation is simple by removing the springs from the horizontal pin to which they are attached.



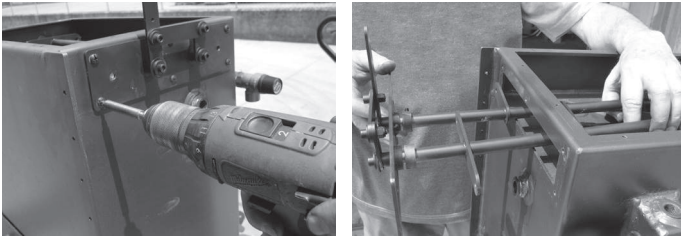
To do this, the horizontal pin can be pulled through a hole in the wall of the thermostove body.



Now the upper section to the heat exchanger is free from any encumbrance so as to allow a perfect cleaning. Once a year is also recommended to clean the upper compartment of the exchanger. To make a proper cleaning is recommended to suck the ash, remove all horizontal joints with a screwdriver, then again suck the ash.



The transaction can be completed with a screwdriver by removing the wall of the thermostove and removing all horizontal joints.



Following the cleaning of the upper compartment of the exchange section, store the upper closure cover. This cover must be closed, as well as with normal screws, with webbing in ceramic fiber rope to ensure the watertight closure of the thermostove.

This general cleaning should be carried out at the end of the season in order to facilitate the general removal of all residues of combustion, without waiting too long, because with time and humidity these residues can become compacted.

Check the seal of the ceramic fiber gaskets on the door of the thermostove.

Then clean the flue system especially near the fittings to "T" and any horizontal sections.



**For your safety, the frequency of cleaning the smoke discharge system must be determined on the basis of how the thermostove is used.**

**In case of failure or inadequate cleaning of the heater may have function problems such as:**

- poor combustion
- blackening of the glass
- clogging of grate with accumulation of ash and pellets
- ash deposit and excessive deposits on the heat exchanger resulting in poor performance.

**The check of electromechanical components must be performed only by qualified personnel with technical knowledge of electricity and combustion.**

We recommend that an annual maintenance service is carried out, preferably under a programmed service contract. The essential part of this service is a visual and functional check on the following components:

- reduction motor
- smoke expulsion fan
- smoke sensor
- heat-exchanger fan
- ignition sparkplug
- resettable pellet thermostat
- room temperature sensor
- pressostat
- motherboard
- fuse protecting panel - motherboard



**These operations must be performed by a qualified technician, or the user who will take responsibility in the event of damage during maintenance.**

**Perform this maintenance heater cold and in the absence of electricity. If such maintenance is performed by an authorized service center is the responsibility of the customer.**

### Surface cleaning

The thermostove is a product by heating, presents the external surfaces particularly hot.

For this reason, we recommend extreme caution when operating in particular:

- Do not touch the thermostove body and the various components, do not approach the door, it could cause burns;
- Do not touch the exhaust fumes;
- Do not perform any type of cleaning;
- Do not dump the ashes;
- Do not open the ash tray;
- Be careful that children do not come close.

All cleaning of all parts must be carried out with the stove completely cold and the plug disconnected.

To clean the surfaces, use a rag dampened with water or with water and a neutral detergent.



**The use of aggressive detergents or thinners can damage the surfaces of the thermostove. Before using any detergent it is advisable to try it on a small section out of sight or contact the Authorized Assistance Centre for information regarding the product.**

## Warnings for cleaning

All cleaning of all parts must be carried out with the stove completely cold and the plug disconnected.

Before effecting any maintenance operation or cleaning on the stove, take the following precautions:

- be sure that all parts of the stove are cold
- be sure that the ashes are completely cold;
- be sure that the general switch is in the "OFF" position;
- be sure that the plug is pulled out of the socket to avoid accidental contact;
- Once the maintenance phase is completed check that everything is in order as per before the intervention (the brazier is placed correctly).

Any kind of tampering or unauthorized substitution of non-original of the thermostove can be hazardous to the safety of the operator and relieves the manufacturer from any civil or criminal liability. Use only original spare parts. Replace a worn before failure promotes the prevention of injuries resulting from accidents caused by the sudden failure of the components.



**After 1300 hours of operation of the heater will appear on the lower display the word "SERV", please contact your Authorized Service Center for cleaning and routine maintenance.**



**Follow carefully the following cleaning instructions. Failure to follow these instructions could create problems with the operation of the thermostove.**

## Problems and solutions



**All repairs must be carried out exclusively by a specialised technician, with the stove completely cold and the electric plug pulled out. Is prohibited from any unauthorized modification to the device and the replacement of parts with other non-original. The operations marked in bold type must be carried out by specialised personnel.**

### Check for proper combustion of the shape and color of the flame

PROBLEM	POSSIBLE CAUSE	REMEDY
The flame thickens at the base and the tip has not pulled upwards.	1. Bad regulation that determines: <ul style="list-style-type: none"> <li>• Too full of pellets</li> <li>• Low fan speed</li> </ul> 2. The duct is obstructed or there are pressures that hamper the smooth evacuation of fumes	1. Define the adjustment of the stove <b>2. Clean the smoke duct and check the pressure switch that measures the proper depression of the chimney</b>
Flame swollen and bursting with color from orange to yellow with dark tips	1. Combustion wrong 2. Flame oxygen deficient	1. Define the adjustment of the stove 2. Make sure the air duct up to the brazier is not obstructed <b>3. Contact your Authorized Assistance Center</b>

In normal combustion, the flame should have a tapered shape, compact, with character "lively" and with the tips tend to be vertical or crushed towards the back of the firebox. You have to have the feeling that the flame is pulled upwards.

## Anomalies related to the scope mechanical or electronic

PROBLEM	POSSIBLE CAUSE	REMEDY
Pellet not being fed into the combustion chamber.	<ol style="list-style-type: none"> <li>1. Pellet hopper empty</li> <li>2. Feeder screw blocked by sawdust</li> <li>3. Reduction motor defective</li> <li>4. Defective electronic board</li> <li>5. One of the thermostats with manual reset is triggered</li> </ol>	<ol style="list-style-type: none"> <li>1. Refill pellet hopper</li> <li><b>2. Empty the hopper and manually free the feeder screw of sawdust</b></li> <li><b>3. Replace reduction motor</b></li> <li><b>4. Replace electronic board</b></li> <li>5. Reset on the back of the thermostove the safety thermostat after verifying the cause</li> </ol>
The stove does not run	<ol style="list-style-type: none"> <li>1. Plug out of place</li> <li>2. Lack of electricity supply</li> <li>3. Parameter suction power to change</li> <li>4. Pellet or water sensor in lockout</li> <li>5. Fuse blown</li> <li>6. Obstruction of nests or foreign bodies in the chimney or fireplace</li> </ol>	<ol style="list-style-type: none"> <li>1. Check the correct position of the sparkplug in the grate</li> <li>2. Check that the electric socket is plugged in and that the main switch is in position "I"</li> <li><b>3. Contact your Authorized Assistance Center</b></li> <li>4. Wait for the cooling of the pellets or water tank and turn on the thermostove</li> <li><b>5. Replace the fuse</b></li> <li>6. Remove all foreign matter from the chimney or flue outlet of the barrel. It is recommended that the intervention of a chimney sweep</li> </ol>
The fire goes out or the stove stops automatically	<ol style="list-style-type: none"> <li>1. Pellet hopper empty</li> <li>2. Pellets not being fed in</li> <li>3. Intervention of pellet temperature sensor</li> <li>4. Door not closed properly or gaskets worn</li> <li>5. Boiler temperature is too high</li> <li>6. Unsuitable pellets</li> <li>7. Low pellet feed rate</li> <li>8. Combustion chamber dirty</li> <li>9. Smoke outlet obstructed</li> <li>10. Smoke extraction motor failed</li> <li>11 Pressure switch faulty or defective</li> </ol>	<ol style="list-style-type: none"> <li>1. Refill pellet hopper</li> </ol> <p>If it is first ignition the fuel, having to go the route that goes from the tank to the brazier, may not be able to arrive on time and in the right amount programmed</p> <ol style="list-style-type: none"> <li><b>2. If after repeated ignitions did not appear in the flame, even with regular supply of pellets, the problem may be related to the components of the heater or the improper installation</b></li> <li>3. Let the stove cool down completely, reset the thermostat till lockout ceases, relight stove; if problem persists, contact technical assistance</li> <li>4. Close the door or <b>replace the gaskets with original spare parts</b></li> <li><b>5. Check for proper operation of the water pump, if necessary, replace the component</b></li> <li>6. Change to a type of pellet recommended by the manufacturer</li> <li><b>7. Have the fuel feed rate checked by technical service</b></li> <li>8. Clean the combustion chamber, following instructions in the manual</li> <li>9. Clean the smoke duct</li> <li><b>10. Check the motor and replace if necessary</b></li> <li><b>11. Replace the pressure</b></li> </ol>
The stove runs for a few minutes and then goes out.	<ol style="list-style-type: none"> <li>1. Lighting cycle not completed</li> <li>2. Temporary failure of electricity supply.</li> <li>3. Smoke duct obstructed.</li> <li>4. Temperature sensors defective or broken.</li> <li>5. Sparkplug failure.</li> </ol>	<ol style="list-style-type: none"> <li>1. Re-run lighting cycle</li> <li>2. See previous instruction</li> <li>3. Clean smoke duct</li> <li><b>4. Check and replace sensors as necessary</b></li> <li><b>5. Check the plug and replace if necessary</b></li> </ol>



Pellet build up in grate, door glass gets dirty and flame is weak	<ol style="list-style-type: none"> <li>1. Insufficient combustion air</li> <li>2. Pellets damp or unsuitable</li> <li>3. Smoke extractor motor broken</li> <li>4. Bad adjustment. Wrong ratio between air and pellet</li> </ol>	<ol style="list-style-type: none"> <li>1. Check that the room air intake is present and free. Check that the combustion air filter on the pipe Ø 5 cm for air inlet is not obstructed. Clean the grate and check that all the airways are clear. Carry out a general cleaning of the combustion chamber and the smoke duct. Check the state of the door gaskets</li> <li>2. Change the type of pellet</li> <li><b>3. Check the motor and replace if necessary</b></li> <li><b>4. Contact your Authorized Assistance Center</b></li> </ol>
The smoke extraction motor does not work	<ol style="list-style-type: none"> <li>1. No electrical supply to the thermostove</li> <li>2. The motor is broken</li> <li>3. Defective electronic board</li> <li>4. Control panel broken</li> </ol>	<ol style="list-style-type: none"> <li>1. Check the supply voltage and the protection fuse</li> <li><b>2. Check the motor and capacitor and replace if necessary</b></li> <li><b>3. Replace electronic board</b></li> <li><b>4. Replace the control panel</b></li> </ol>
The air fan convention never stops	<ol style="list-style-type: none"> <li>1. Temperature sensor temperature control defective or broken</li> <li>2. Fan failure</li> </ol>	<ol style="list-style-type: none"> <li><b>1. Check operation of the sensor and replace if necessary</b></li> <li><b>2. Check operation of the motor and replace if necessary</b></li> </ol>
In the automatic position the thermostove always runs at full power	<ol style="list-style-type: none"> <li>1. Room thermostat set to maximum</li> <li>2. Temperature sensor defective</li> <li>3. Control panel defective or broken</li> </ol>	<ol style="list-style-type: none"> <li>1. Reset the thermostat temperature</li> <li><b>2. Check the operation of the sensor and replace if necessary</b></li> <li><b>3. Check the panel and replace if necessary</b></li> </ol>
The thermostove starts up "alone"	<ol style="list-style-type: none"> <li>1. Incorrect programming of the cronothermostat</li> </ol>	<ol style="list-style-type: none"> <li>1. Check the settings of the cronothermostat</li> </ol>
The power does not change even if you manually adjust	<ol style="list-style-type: none"> <li>1. The board is set to automatic correction of power in proportion to the temperature</li> </ol>	<ol style="list-style-type: none"> <li><b>1. Contact your Authorized Assistance Center</b></li> </ol>

#### Anomalies related to the plumbing circuit

PROBLEM	POSSIBLE CAUSE	REMEDY
No increase in temperature with stove in operation	<ol style="list-style-type: none"> <li>1. Incorrect combustion adjustment</li> <li>2. Boiler/system dirty</li> <li>3. Insufficient stove power</li> </ol>	<ol style="list-style-type: none"> <li>1. Check parameters</li> <li>2. Check and clear the boiler</li> <li>3. Check that the stove is properly sized for the requirements of the system</li> </ol>

PROBLEM	POSSIBLE CAUSE	REMEDY
Condensation in boiler	<ol style="list-style-type: none"> <li>1. Incorrect setting maximum water temperature in the boiler</li> <li>2. Insufficient fuel consumption</li> </ol>	<ol style="list-style-type: none"> <li>1. Set the stove to a higher temperature. The maximum water temperature in the boiler is 65 ° C and can not be set below 40 ° C or above 80 ° C. It is advisable to never adjust the temperature below 50/55 ° C to avoid condensation in the boiler. <b>Adjust the power of the pump at a higher temperature to 50/55 ° C.</b></li> <li>2. <b>Contact your Authorized Assistance Center</b></li> </ol>
Radiators cold in winter but the thermostove boils	<ol style="list-style-type: none"> <li>1. Circulator does not run because blocked</li> <li>2. Radiators have air in them</li> </ol>	<ol style="list-style-type: none"> <li>1. <b>Free up the circulator by removing the plug and turning the shaft with a screwdriver. Check the electrical connections of the same, replace if necessary</b></li> <li>2. <b>Vent the radiators</b></li> </ol>
Hot water in not provided	<ol style="list-style-type: none"> <li>1. Circulator pump blocked</li> </ol>	<ol style="list-style-type: none"> <li>1. <b>Free the circulator pump</b></li> </ol>
The thermostove boils under “modulation” that reaches the temperature set on the thermostat of the thermostove	<ol style="list-style-type: none"> <li>1. It ‘been set to a value of thermostat too high</li> <li>2. It was set too much power to the implant.</li> </ol>	<ol style="list-style-type: none"> <li>1. Lower the temperature in the boiler</li> <li>2. Reduce the value of operating power</li> </ol>
The thermostove goes into “modulation” as it reaches the temperature set on the thermostat of the thermostove even at low temperatures of the water in the boiler	<ol style="list-style-type: none"> <li>1. Modify the parameter for the maximum smoke temperature modulation to edit</li> <li>2. Dirty stove: the fumes are too high temperature.</li> </ol>	<ol style="list-style-type: none"> <li>1. <b>Contact your Authorized Assistance Center</b></li> <li>2. <b>Clean the tube bundle</b></li> </ol>
High variability of domestic hot water temperature	<ol style="list-style-type: none"> <li>1. Water flow is too high</li> </ol>	<ol style="list-style-type: none"> <li>1. <b>Reduce the flow of water (4/6 liters per minute)</b></li> </ol>
Exits little hot water	<ol style="list-style-type: none"> <li>1. Insufficient water pressure in the network</li> <li>2. Tap or mixer clogged with limescale</li> <li>3. Water group clogged</li> <li>4. The heat exchanger does not work</li> <li>5. Air in: pump cavitation for the presence of air, the water does not rotate.</li> </ol>	<ol style="list-style-type: none"> <li>1. <b>Check the setting of the pressure reducing valve</b></li> <li>2. <b>Install a water demineralizer</b></li> <li>3. <b>Check and clean the sanitary kit</b></li> <li>4. <b>Replace the plate heat exchanger</b></li> <li>5. <b>Bleed the brake system, remove air by venting the radiators.</b></li> </ol>



**Never turn off the heater by removing electricity.**

**Let always complete the shutdown cycle, otherwise you may damage the structure and have trouble lighting in the future.**



# NOTES

